

Bayside Bench

21S - Bayside Bench

DRAFFIN
Street Furniture



The Bayside Benches are made in a variety of standard lengths featuring an aluminium frame with three standard end panel styles and Draffin's full array of standard batten materials. Contoured end battens inset inside the aluminium frames give it a luxe aesthetic. With its modern appeal, Bayside furniture is suitable for placement in any location.

Length Options *(pictured next page)*

- 2000mm
- 1800mm
- 1500mm
- 1200mm
- 1000mm
- 600mm

End Panel Style

- Frame
- Blank
- Grooved
- Custom

Batten Material *(See batten guide)*

60mm x 30mm

- Spotted Gum
- Anodised Aluminium
- Powdercoated Aluminium *(See colour guide)*
- Timber-Look Aluminium

Frame Material

- Powdercoated Aluminium *(See colour guide)*

Mounting Options

- Bolt Down
- Include Inground Anchors

Other Options

- Custom Dimensions
- Armrests

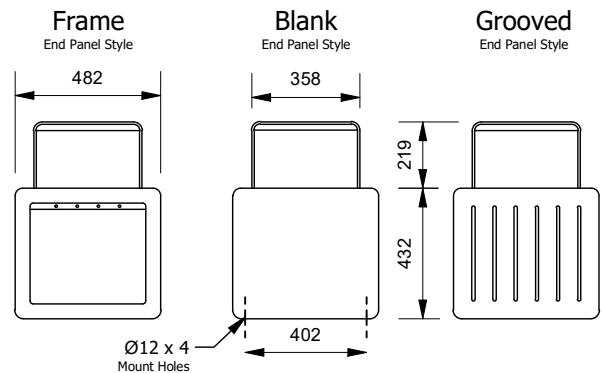

Plan

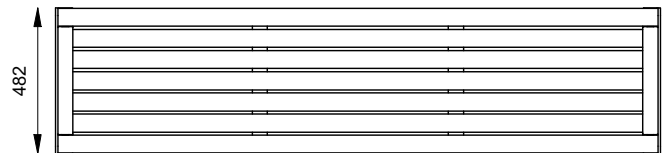

Front View

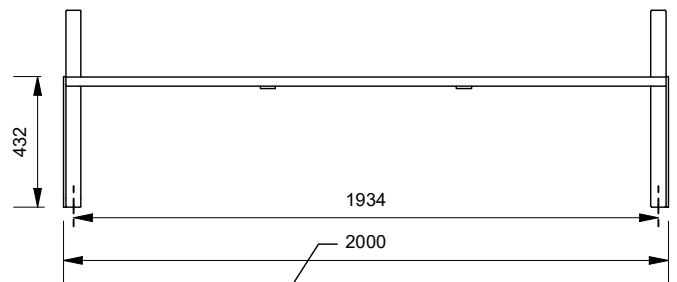

6 Standard Sizes Available *(Next Page)*

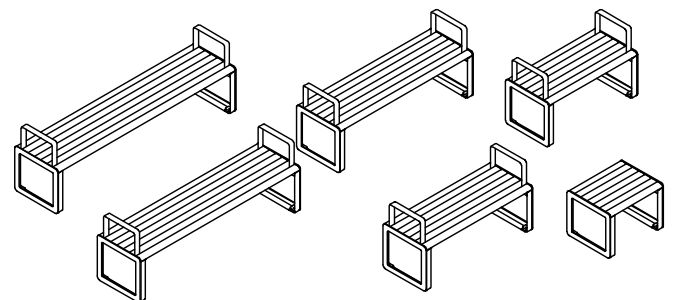
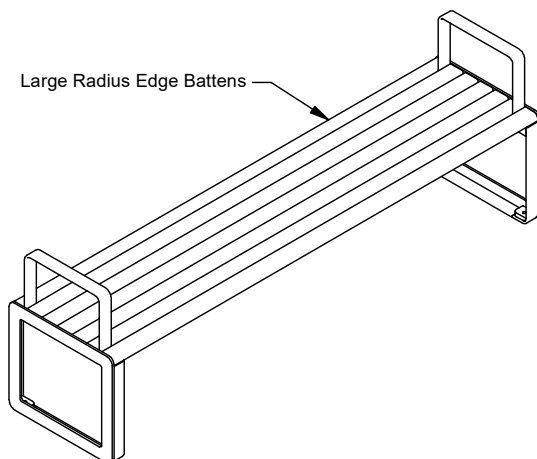

More information:

Go to the website for spec inspiration.

21S - Bayside Seat with Back

<https://draffin.com.au/product/bayside-straight-bench/>

Batten Guide

<https://draffin.com.au/batten-guide/>

Powdercoat Colour Guide

<https://draffin.com.au/colour-guide/>

DDA guide

<https://draffin.com.au/dda/>

Bayside Seat with Back

20S - Bayside Seat with Back

DRAFFIN
Street Furniture

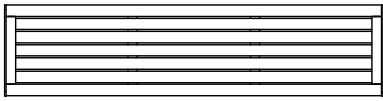

2000mm Seat
(4 Seater)

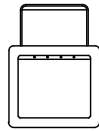
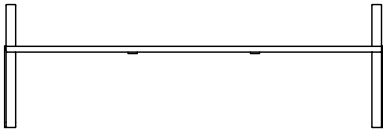
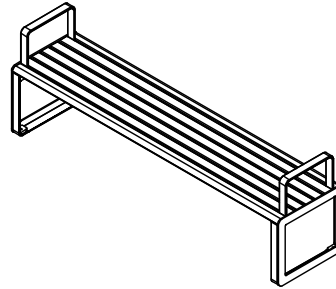

(All Benches)



1800mm Seat
(3 Seater)

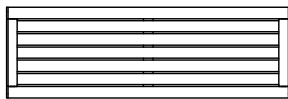
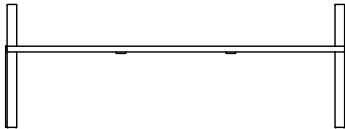
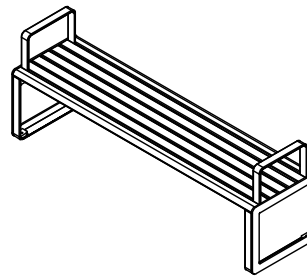

1500mm Seat
(2.5 Seater)

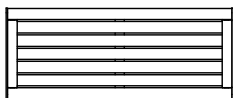
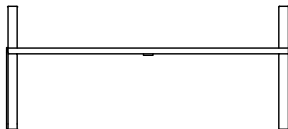
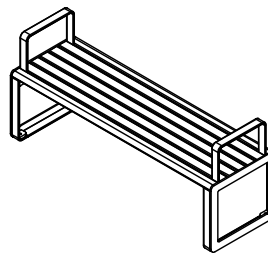

1200mm Seat
(2 Seater)

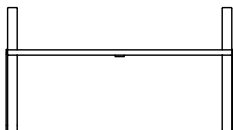
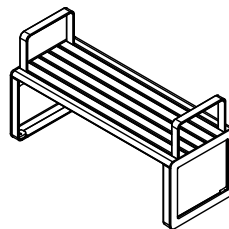

Seat - 600mm
(1 Seater)

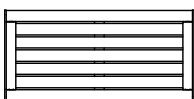
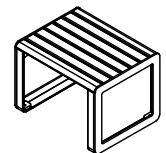

1000mm Seat
(2 Seater)

