

Standard Picnic Table

Model 115 - Standard Picnic Table

DRAFFIN
Street Furniture



The Standard Picnic Table is a sturdy and economical picnic table with 110mm x 30mm battens in a range of materials. Hot-dip galvanised mild steel frames, braced for extra rigidity making the Standard Picnic Table a durable and dependable choice for public placement.

Table Size

- 1750mm long
- 1000mm long

Batten Options (See Batten Guide)

Battens 110mm x 30mm

- Spotted Gum Timber
- Enviroslat Composite
- Anodised Aluminium
- Powdercoated Aluminium
- Timber-Look Aluminium - Mountain Gum
- Timber-Look Aluminium - Alpine Ash
- Timber-Look Aluminium - Ironbark

Mounting Options

- Bolt Down
- Freestanding
- In-Ground Anchors

Other Options

- Powdercoated Frames (See Colour Guide)
- Umbrella Hole
- Chess Board Insert

115 -
1750mm long
Standard Picnic Table

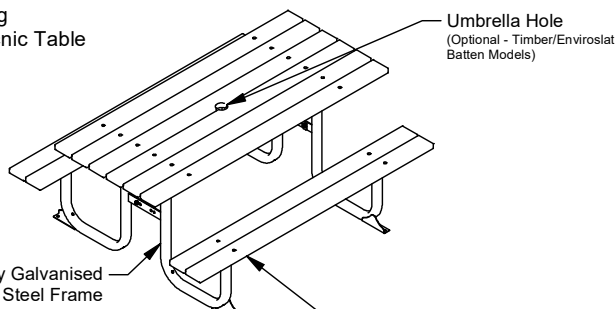

115/1000 -
1000mm long
Standard Picnic Table

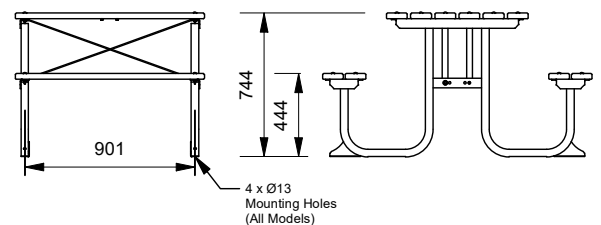
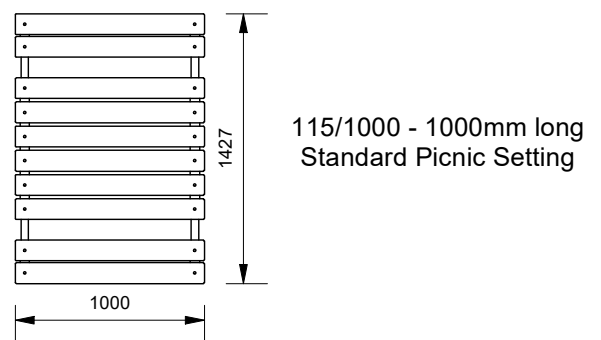
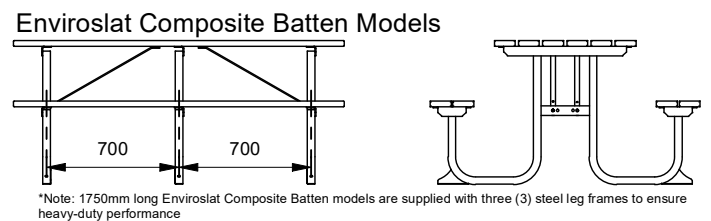
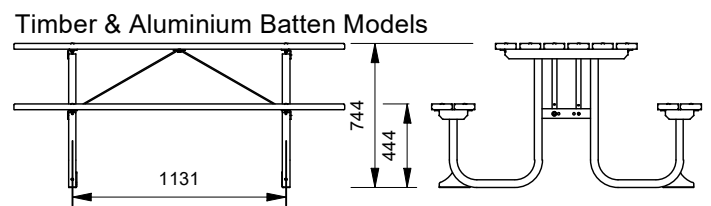
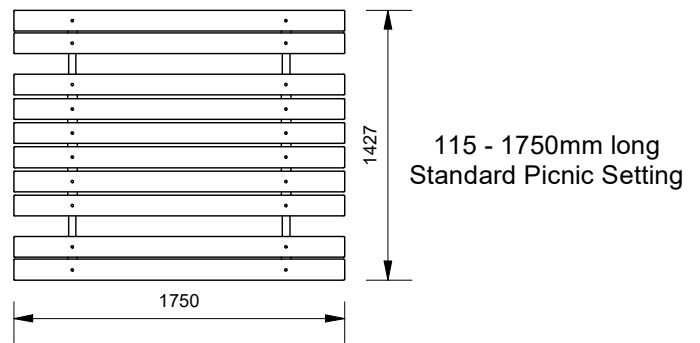
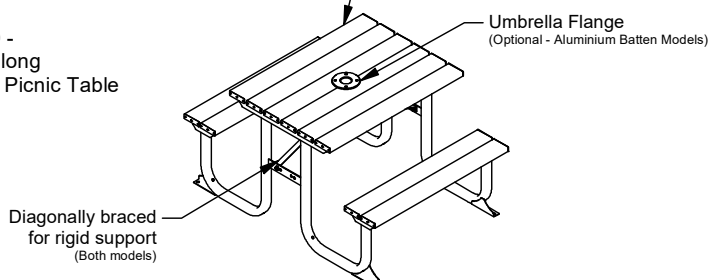

More information:
Go to the website for spec inspiration.
115 - Standard Picnic Setting
<https://draffin.com.au/product/standard-picnic-table/>

Batten Guide
<https://draffin.com.au/batten-guide/>

Colour Guide
<https://draffin.com.au/colour-guide/>