

Cairns Seat with Back

89376 - Cairns Seat with Back

DRAFFIN
Street Furniture



The Cairns Seat with Back has fully welded frames for extra strength, and are manufactured in mild or stainless steel with your preference of finish. The entire suite has a generous batten profile with an extra large radius on all edges providing a luxurious appeal.

Batten Material (See batten guide)

- Spotted Gum 135mm x 35mm
- Enviroslat 140mm x 35mm

Frame Material

- Galvanised Mild Steel
- 304 Stainless Steel - Brushed
- 304 Stainless Steel - Bead Blasted
- 316 Stainless Steel - Brushed
- 316 Stainless Steel - Bead Blasted

Mounting Options

- Bolt Down

Other Options

- Powdercoat Frames (See colour guide)
- Armrests
- Custom Length

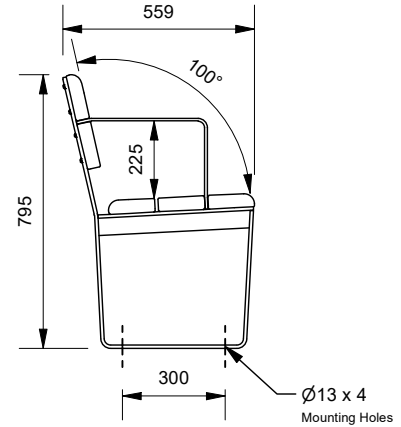

Plan

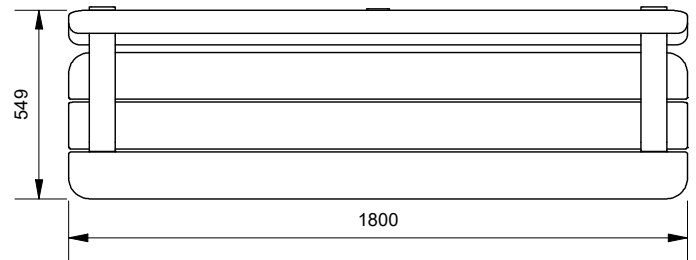

Front View

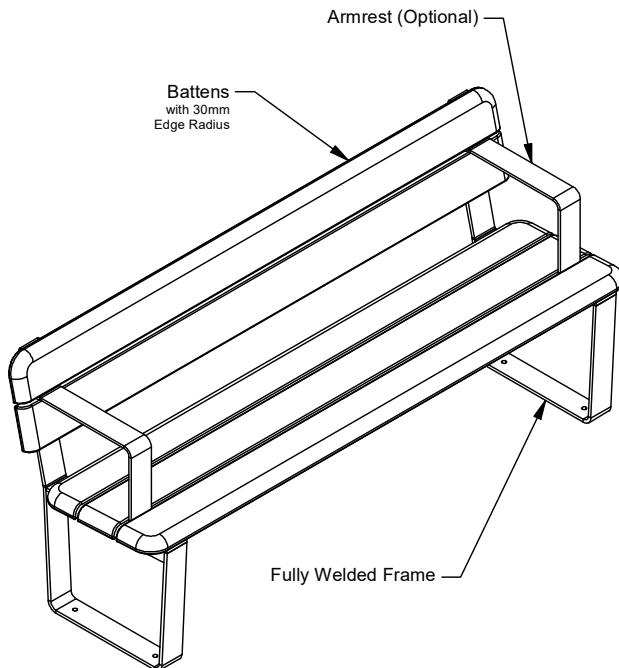
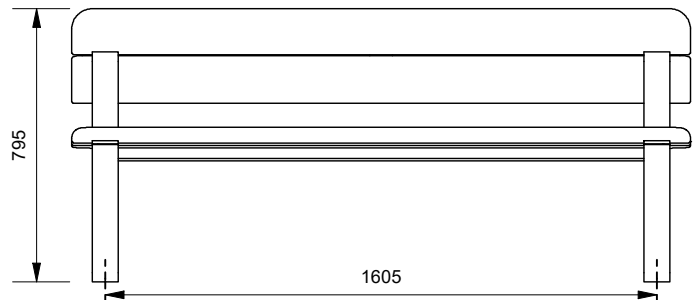

More information:

Go to the website for spec inspiration.

89376 - Cairns Seat with Back

<https://draffin.com.au/product/cairns-seat-with-back/>

Batten Guide

<https://draffin.com.au/batten-guide/>

Colour and Plinth Guide

<https://draffin.com.au/colour-guide/>

Stainless Steel Guide

<https://draffin.com.au/stainless-steel-guide/>

DDA guide

<https://draffin.com.au/dda/>