

900 Series Pivot Chute Cover 120lt Bin Surround

Model 910 - 900 Series Pivot Chute Cover 120lt Bin Surround

DRAFFIN
Street Furniture



900 series Pivot Chute Cover Bin Surrounds prevent wildlife access with a soft return self closing stainless steel chute. Ideal for bushland or zooscape applications. 900 Series Bin Surrounds have a fully welded frame for strength and are clad with battens or recycled HDPE panels to soften their appearance.

Size

- 120lt

Cover Style

- Pivot Chute Cover

Cover Material

- Powdercoated Mild Steel (See Colour Guide)
- 304 Stainless Steel
- 316 Stainless Steel

Cover Chute Material

- 304 Stainless Steel
- 316 Stainless Steel

Frame Material

- Powdercoated Mild Steel (See Colour Guide)
- 304 Stainless Steel
- 316 Stainless Steel

Batten Material (See Batten Guide)

65mm x 19mm

- Spotted Gum
- Enviroslat
- Anodised Aluminium
- Powdercoated Aluminium (See Colour Guide)
- Timber-Look Aluminium - Alpine Ash
- Timber-Look Aluminium - Mountain Gum
- Timber-Look Aluminium - Ironbark
- or
- Recycled HDPE Panels - Plain (See Recycled Plastic Colour Guide)
- Recycled HDPE Panels - Routed Pattern (See Pattern Guide)

Other Options

- Communication Signage (See Signage Guide)
- Cover Face Plates
- Dog Bag Dispenser (External Mounted - Model 88737)

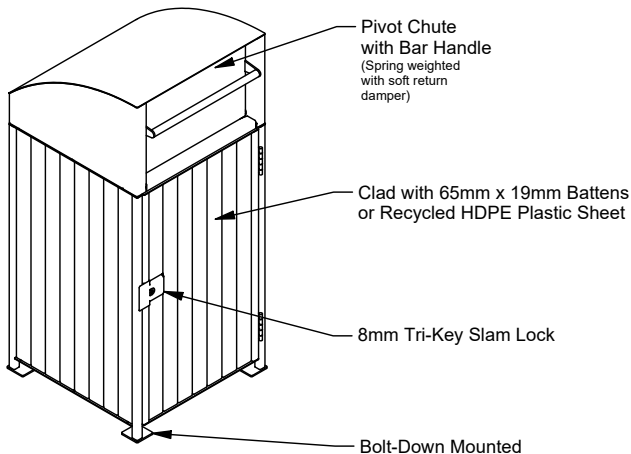
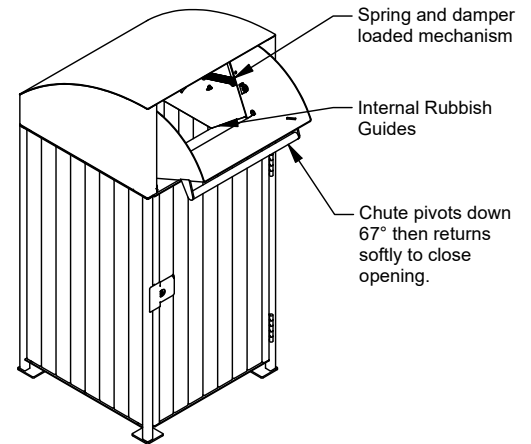
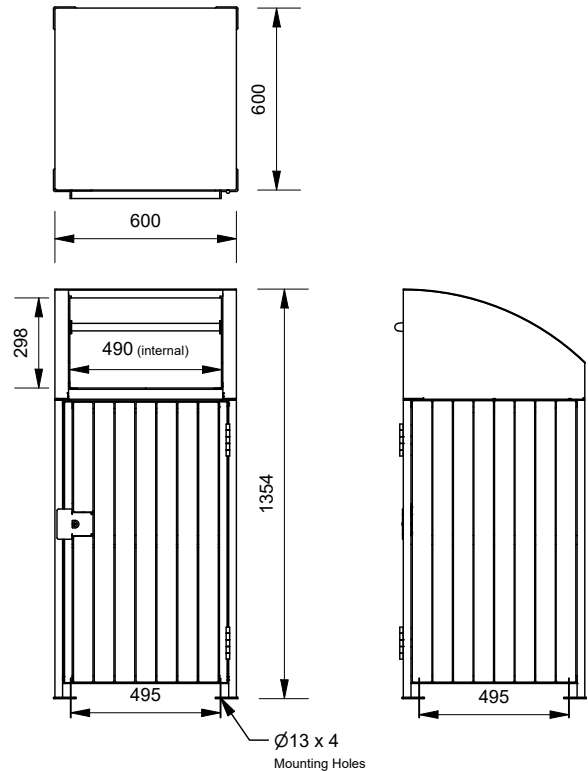

More information:
Go to the website for spec inspiration.

910 - 120lt 900 Series Pivot Chute Cover Bin Surround
<https://draffin.com.au/product/800-series-with-pivot-chute-cover/>

Colour Guide
<https://draffin.com.au/colour-guide/>

Signage Guide
<https://draffin.com.au/signage-guide/>

Batten Guide
<https://draffin.com.au/batten-guide/>

Stainless Steel Guide
<https://draffin.com.au/stainless-steel-guide/>

Recycled HDPE Plastic Guide
<https://draffin.com.au/recycled-plastic-colour-chart/>

900 Series Pivot Chute Cover 120lt Bin Surround

Model 910 - 900 Series Pivot Chute Cover 120lt Bin Surround



Signage options for 900 Series Bin Surrounds

Sign panel variations including sticker

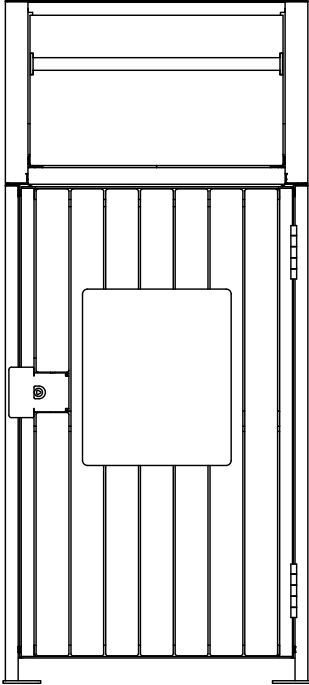

Steel Sign
Panel with Decal

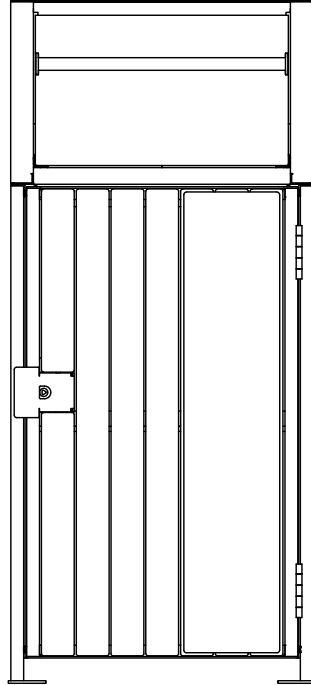

Steel Vertical
Sign Panel with Decal

HDPE Recycled Plastic Panels

(In place of battens)

Plain panels (standard)
or routed patterns
available
(See pattern Guide)

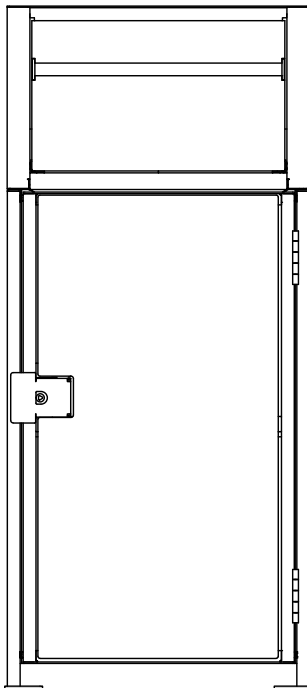

120lt Pivot Chute Cover Openings

Chute opens 67° for refuse to slide into bin. Internal rubbish guides ensure waste falls directly into wheelie bin and not down sides.

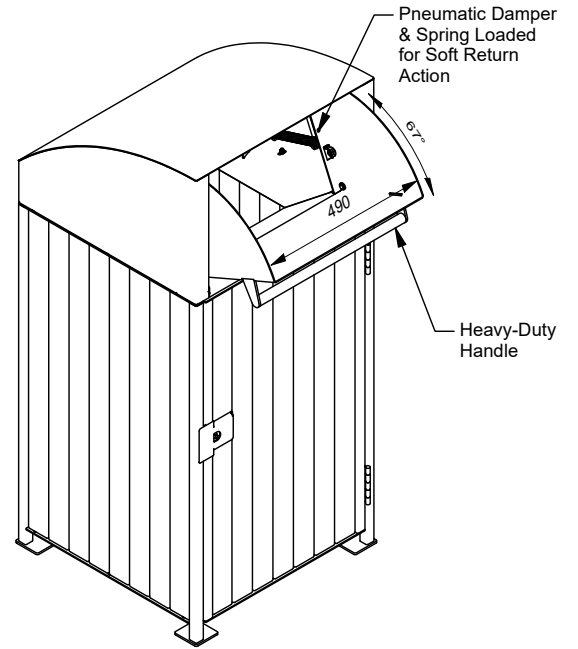

Installation Detail

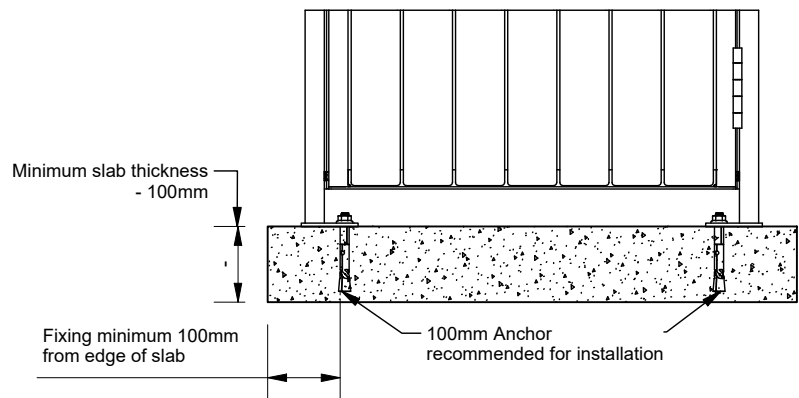

900 Series Pivot Chute Cover 240lt Bin Surround

Model 930 - 900 Series Pivot Chute Cover 240lt Bin Surround

DRAFFIN
Street Furniture



900 series Pivot Chute Cover Bin Surrounds prevent wildlife access with a soft return self closing stainless steel chute. Ideal for bushland or zooscape applications. 900 Series Bin Surrounds have a fully welded frame for strength and are clad with battens or recycled HDPE panels to soften their appearance.

Size

- 240lt

Cover Style

- Pivot Chute Cover

Cover Material

- Powdercoated Mild Steel (See Colour Guide)
- 304 Stainless Steel
- 316 Stainless Steel

Cover Chute Material

- 304 Stainless Steel
- 316 Stainless Steel

Frame Material

- Powdercoated Mild Steel (See Colour Guide)
- 304 Stainless Steel
- 316 Stainless Steel

Batten Material (See Batten Guide)

65mm x 19mm

- Spotted Gum
- Enviroslat
- Anodised Aluminium
- Powdercoated Aluminium (See Colour Guide)
- Timber-Look Aluminium - Alpine Ash
- Timber-Look Aluminium - Mountain Gum
- Timber-Look Aluminium - Ironbark
- or
- Recycled HDPE Panels - Plain (See Recycled Plastic Colour Guide)
- Recycled HDPE Panels - Routed Pattern (See Pattern Guide)

Other Options

- Communication Signage (See Signage Guide)
- Cover Face Plates
- Dog Bag Dispenser (External Mounted - Model 88737)

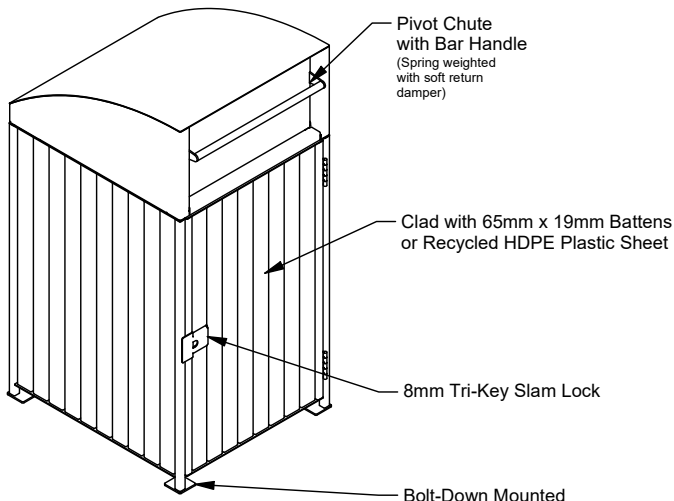
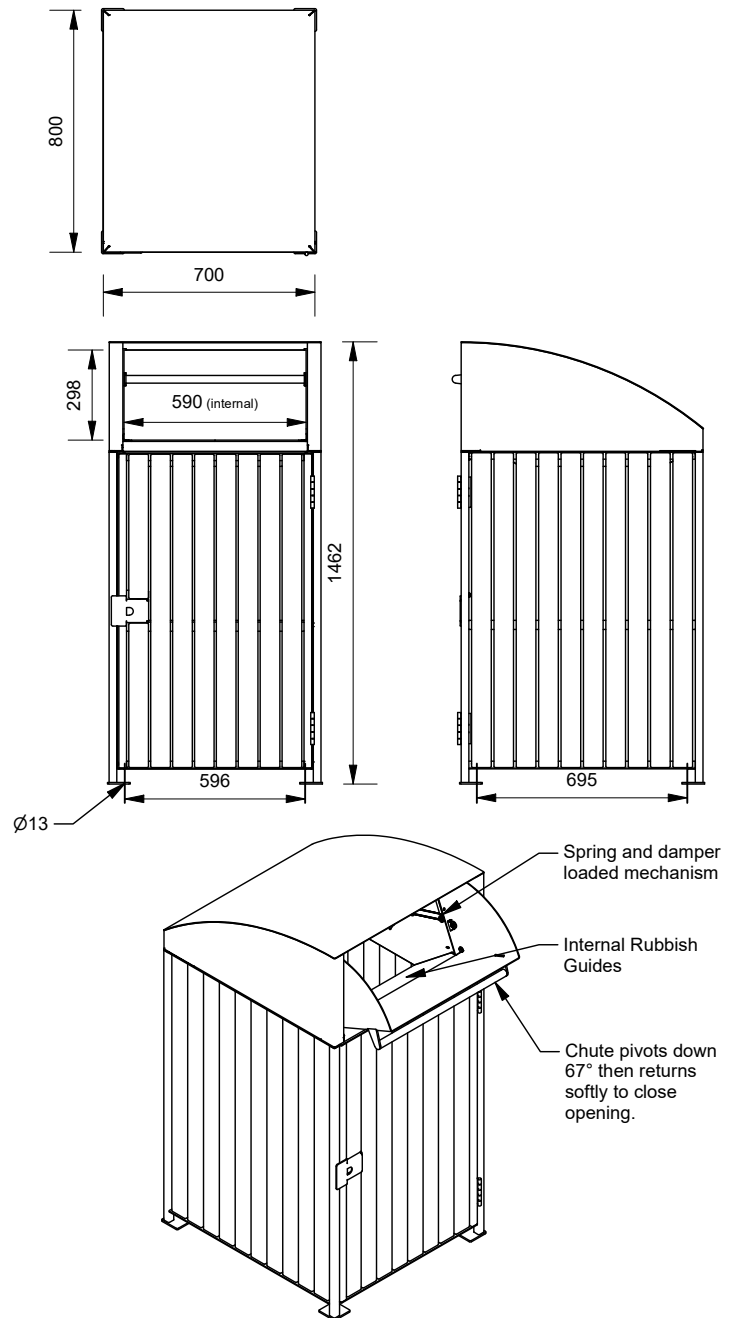

More information:
Go to the website for spec inspiration.

931 - 240lt 900 Series Sloped Cover Bin Surround
<https://draffin.com.au/product/sloped-900-series-timber-clad-bin-surrounds/>

Colour Guide
<https://draffin.com.au/colour-guide/>

Signage Guide
<https://draffin.com.au/signage-guide/>

Batten Guide
<https://draffin.com.au/batten-guide/>

Stainless Steel Guide
<https://draffin.com.au/stainless-steel-guide/>

Recycled HDPE Plastic Guide
<https://draffin.com.au/recycled-plastic-colour-chart/>

900 Series Pivot Chute Cover 240lt Bin Surround

Model 930 - 900 Series Pivot Chute Cover 240lt Bin Surround



Signage options for 900 Series Bin Surrounds

Sign panel variations including sticker

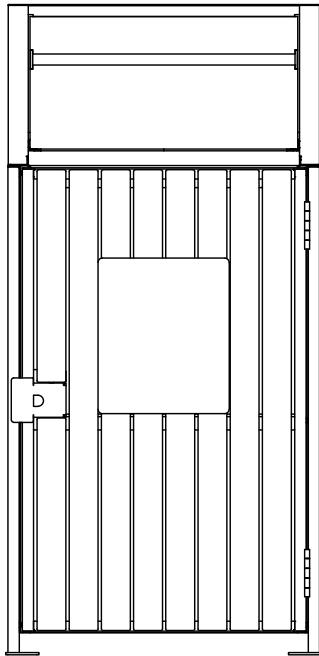

Steel Sign
Panel with Decal

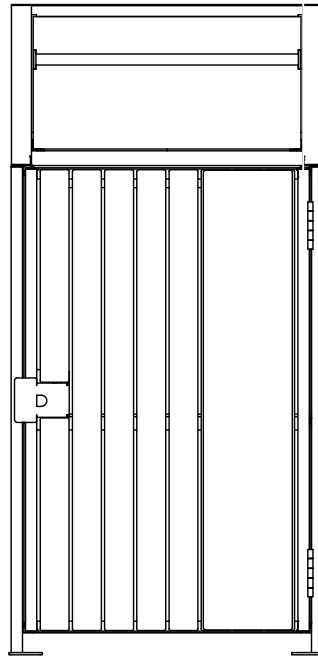

Steel Vertical
Sign Panel with Decal

240lt Pivot Chute Cover Openings

Chute opens 67° for refuse to slide into bin. Internal rubbish guides ensure waste falls directly into wheelie bin and not down sides.

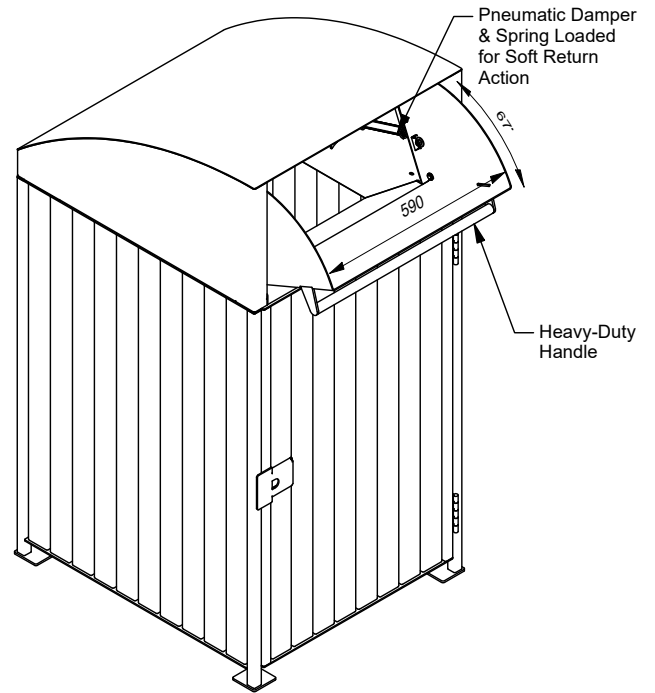

HDPE Recycled Plastic Panels

(In place of battens)

Plain panels (standard)
or routed patterns
available
(See pattern Guide)

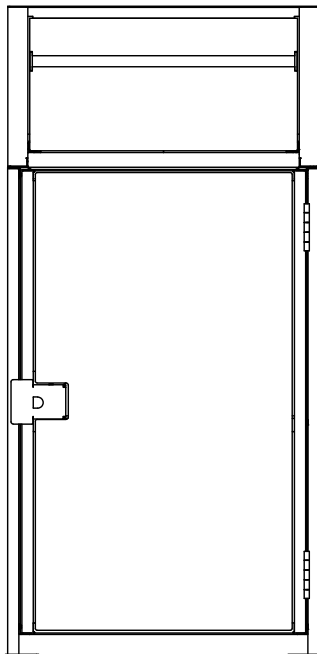

Installation Detail

