

Newcastle Seat with Back

Model 88763 - Newcastle Seat with Back

DRAFFIN
Street Furniture



The Newcastle Seat with Back is engineered to impress with its heavy-duty sub-frame, and lavishly clad in high quality battens of your choice. Part seat, part bench, the backrest with armrest can be optioned on either end. End panels with backing plates include the option to laser cut a design in a combination of materials.

Seat Back Configuration (with Armrest)

- Left
- Right
- Full

Batten Material (See batten guide)

60mm x 40mm

- Spotted Gum
- Enviroslat
- Anodised Aluminium
- Powdercoated Aluminium (See colour guide)
- Timber-Look Aluminium - Alpine Ash
- Timber-Look Aluminium - Mountain Gum
- Timber-Look Aluminium - Ironbark

Sub-Frame Material

- Galvanised Mild Steel

Panel Material

- Weathering Steel
- Powdercoated (Hot Dipped Galvanised Mild Steel)
- 304 Grade Stainless-Steel
- 316 Grade Stainless-Steel

Backing Plate Material

- Weathering Steel
- Powdercoated (Hot Dipped Galvanised Mild Steel)
- 304 Grade Stainless-Steel
- 316 Grade Stainless-Steel

Mounting Options

- Freestanding
- Bolt Down
- Inground Anchors

Other Options

- Standard Laser Cut Panel Design
- Custom Laser Cut Panel Design

Left Hand Backrest Model

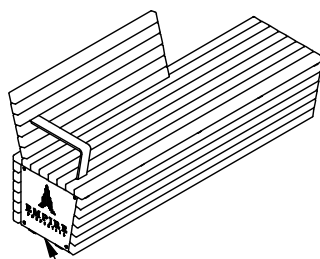

Custom Laser Cut Panel Design*
(Example)

Standard Laser Cut Panel Design*

Armrest located at the same end as backrest

Frame wrapped front to back with battens

Right Hand Backrest Model

Full Backrest Model

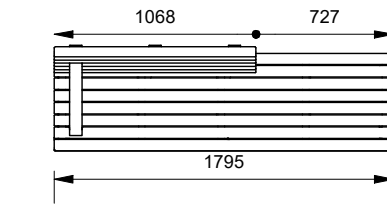
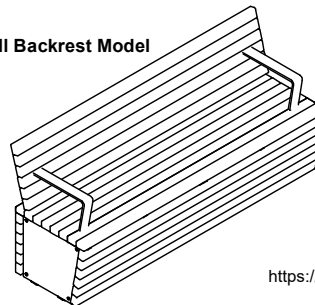

Left Backrest Model

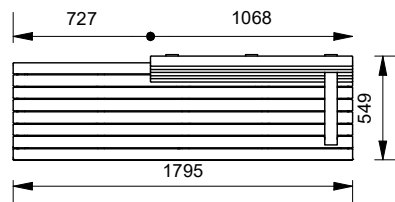
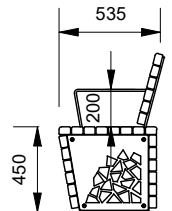
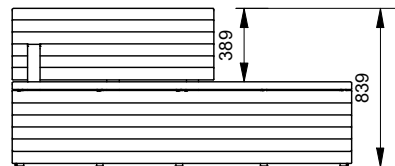

Right Backrest Model

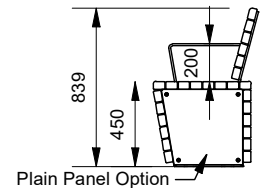
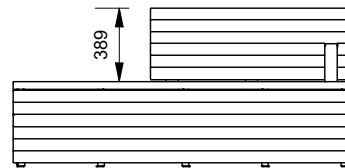

Plain Panel Option

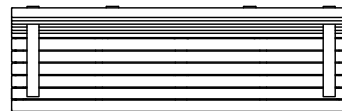

Full Backrest Model

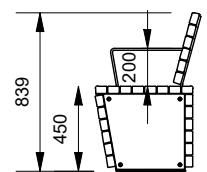
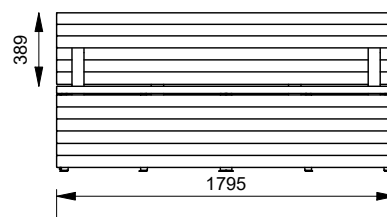

More information:
Go to the website for spec inspiration.

88763 - Newcastle Seat with Back
<https://draffin.com.au/product/newcastle-seat-back/>

Colour Guide
<https://draffin.com.au/colour-guide/>

Batten Guide
<https://draffin.com.au/batten-guide/>

Stainless Steel Guide
<https://draffin.com.au/stainless-steel-guide/>

Weathering Steel Guide
<https://draffin.com.au/weathering-steel-guide/>

*Contrasting back plate behind laser-cut panel