

Hobart Powdercoated 120lt Bin Surround

Model 89199 - Hobart Powdercoated 120lt Bin Surround

DRAFFIN
Street Furniture



The Hobart Powdercoated Bin Surround offers smart, modern design with added styling options to colour coordinate with your space. Powdercoat this bin surround with one colour or two contrasting colours and add signage or laser cut features. Made with 3mm mild steel sheet, the Hobart Bin Range is one of the toughest on the market.

Size

- 120lt

Opening

- Rubbish Frogmouth
- Recycling Round
- Include Rear Opening

Lock System

- Padlock Tabs (Padlock not included)
- Slam Lock

Other Options

- Magnetic Door Latches
- Perforations (See Perforation Guide)
- Laser Cut Logos
- Logo Backing Plates
- Adjustable Leveling Foot Straps
- Communication Signage (See Signage Guide)

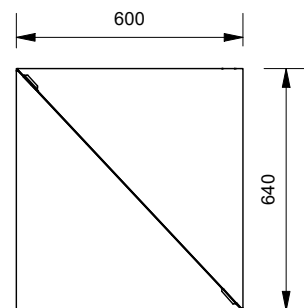
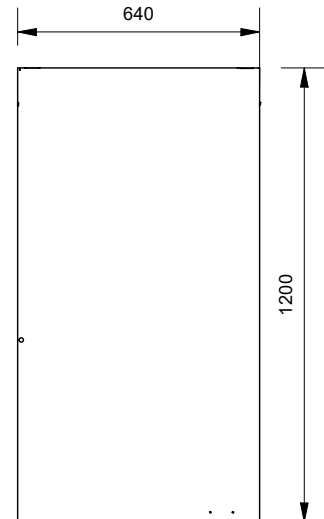
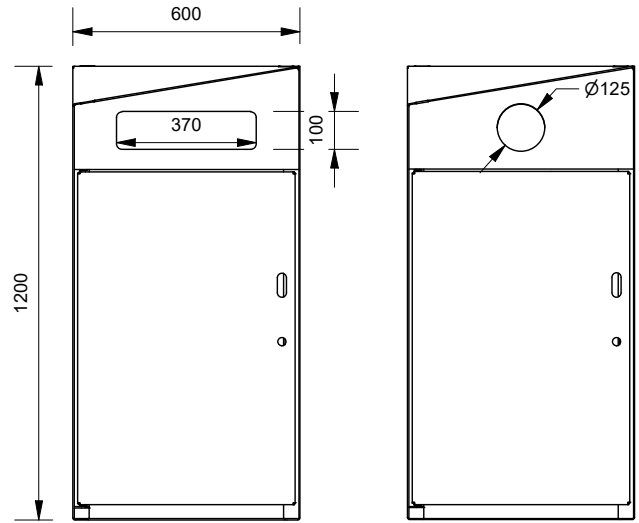

Powdercoated/Zinc Plated
Mild Steel Construction

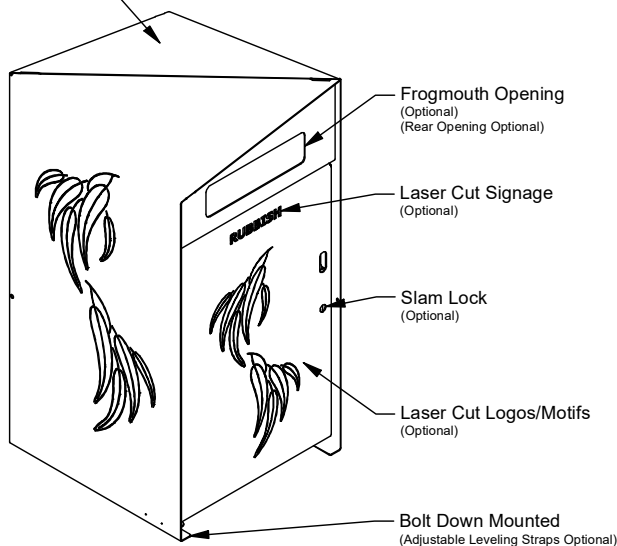

Lock Options

Slam Lock with
8mm Tri-Key
(plus Handle Hole
for easy opening)

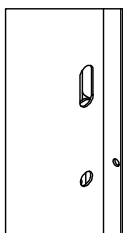

Padlock Tabs to fit
padlock
(Padlock not included)

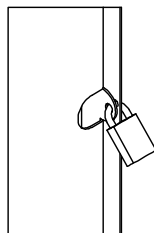

More information:
Go to the website for spec inspiration.
89199 - 120lt Hobart Powdercoated Bin Surround
<https://draffin.com.au/product/hobart-powdercoated-bin-surround/>

Colour Guide
<https://draffin.com.au/colour-guide/>

Signage Guide
<https://draffin.com.au/signage-guide/>

Perforation Pattern Guide
<https://draffin.com.au/perforation-patterns/>

Hobart Powdercoated 120lt Bin Surround

Model 89199 - Hobart Powdercoated 120lt Bin Surround

DRAFFIN
Street Furniture



Standard Openings

Standard Frogmouth
Rubbish Model

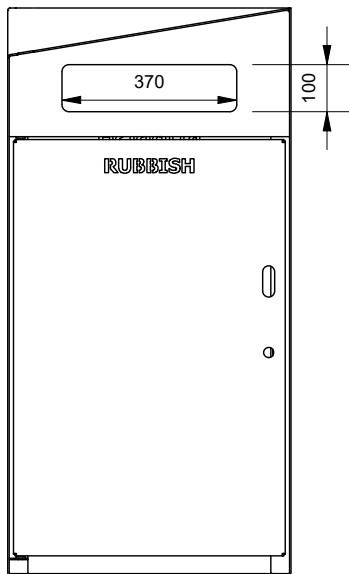

Standard Round
Recycle Model

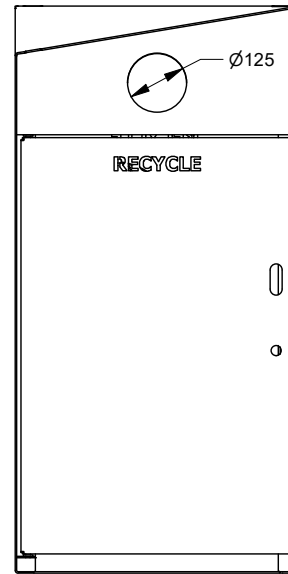

Installation Detail

Installation without Stainless Steel Level Adjustable
Footstrap

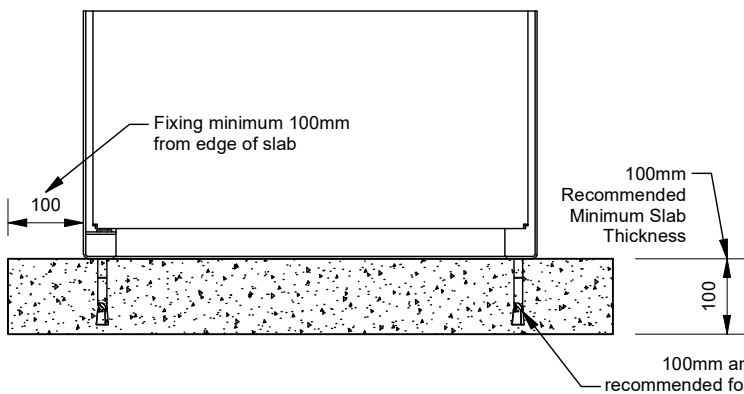

Installation using Stainless Steel Level Adjustable
Footstrap

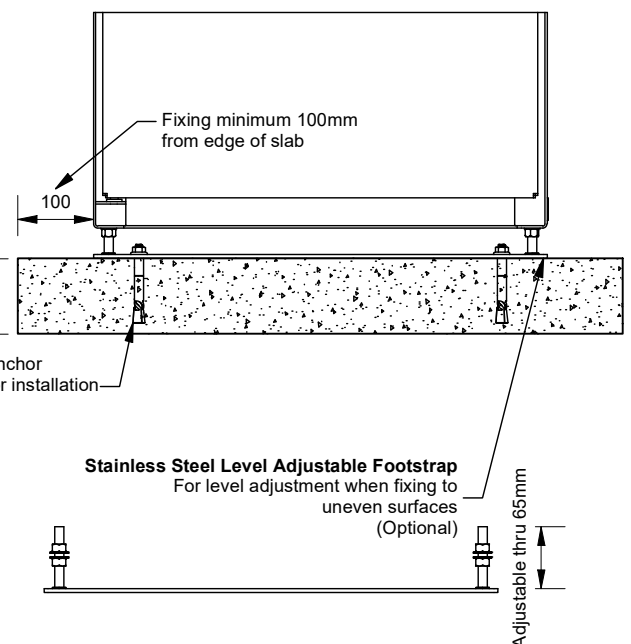

Hobart Powdercoated 240lt Bin Surround

Model 89199 - Hobart Powdercoated 240lt Bin Surround

DRAFFIN
Street Furniture



The Hobart Powdercoated Bin Surround offers smart, modern design with added styling options to colour coordinate with your space. Powdercoat this bin surround with one colour or two contrasting colours and add signage or laser cut features. Made with 3mm mild steel sheet, the Hobart Bin Range is one of the toughest on the market.

Size

- 240lt

Opening

- Rubbish Frogmouth
- Recycling Round
- Include Rear Opening

Lock System

- Padlock Tabs (Padlock not included)
- Slam Lock

Other Options

- Magnetic Door Latches
- Perforations (See Perforation Guide)
- Laser Cut Logos
- Logo Backing Plates
- Adjustable Leveling Foot Straps
- Communication Signage (See Signage Guide)

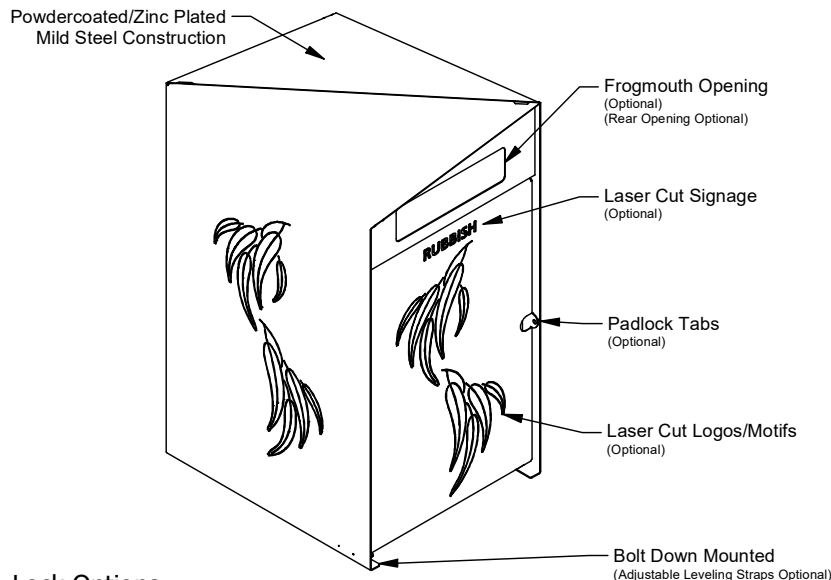
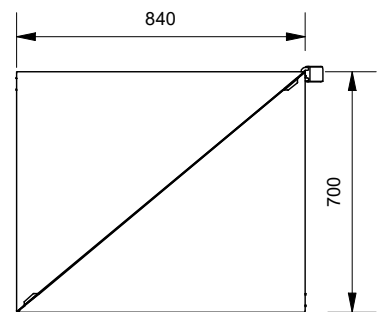
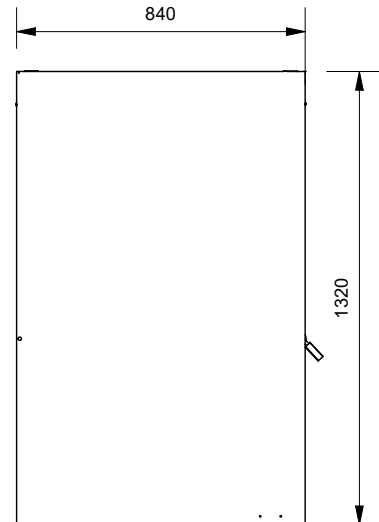
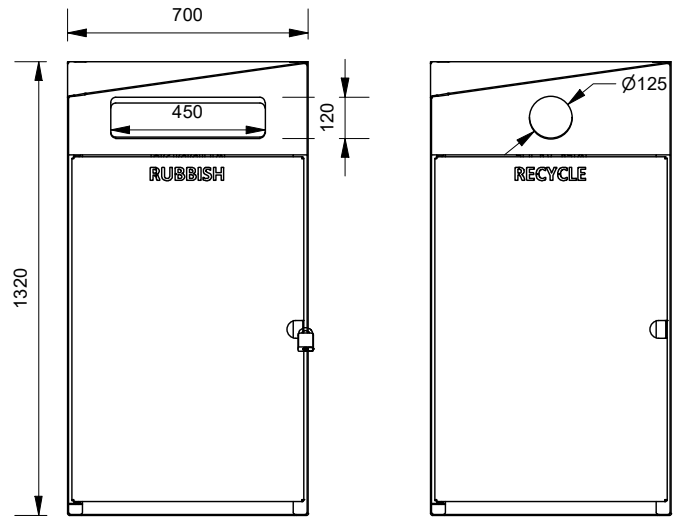

Lock Options

Slam Lock with
8mm Tri-Key
(plus Handle Hole
for easy opening)

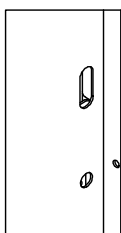

Padlock Tabs to fit
padlock
(Padlock not included)

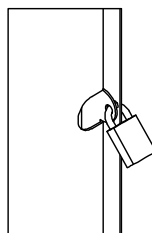

More information:
Go to the website for spec inspiration.
89199 - 240lt Hobart Powdercoated Bin Surround
<https://draffin.com.au/product/hobart-powdercoated-bin-surround/>

Colour Guide
<https://draffin.com.au/colour-guide/>

Signage Guide
<https://draffin.com.au/signage-guide/>

Perforation Pattern Guide
<https://draffin.com.au/perforation-patterns/>

Hobart Powdercoated 240lt Bin Surround

Model 89199 - Hobart Powdercoated 240lt Bin Surround

DRAFFIN
Street Furniture



Standard Openings

Standard Frogmouth
Rubbish Model

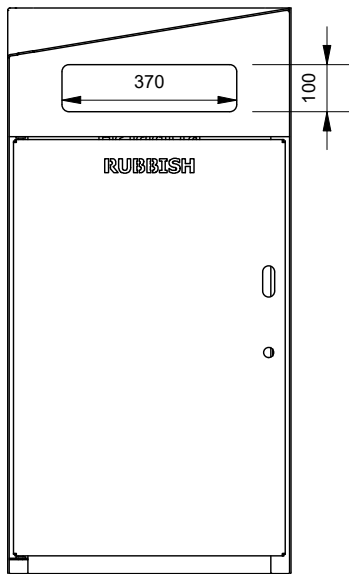

Standard Round
Recycle Model

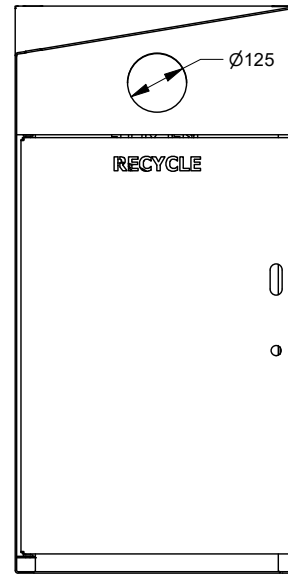

Installation Detail

Installation without Stainless Steel Level Adjustable
Footstrap

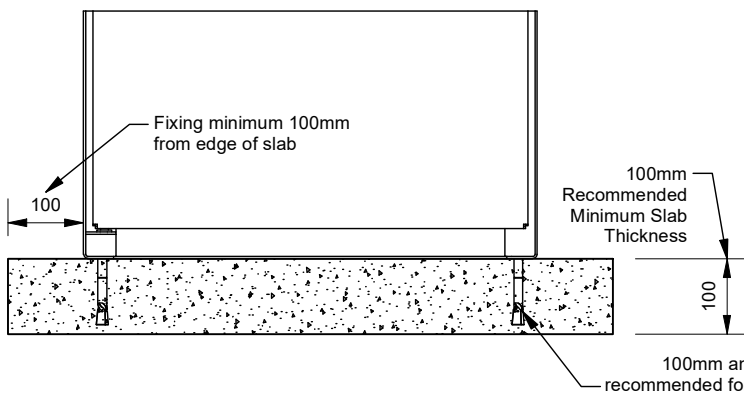

Installation using Stainless Steel Level Adjustable
Footstrap

