

900 Series Low Pyramid Cover 120lt Bin Surround

Model 915 - 900 Series Low Pyramid Cover 120lt Bin Surround

DRAFFIN
Street Furniture



900 series Bin Surrounds with Low Pyramid Covers offer 360 degree access to round openings, primarily used for waste recycling applications. Ideal for high traffic and indoor spaces. The mirror polished stainless steel cover is easy to keep clean. 900 Series Bin Surrounds have a fully welded frame for strength and are clad with battens to soften their appearance.

Size

- 120lt

Cover Style

- Stainless Steel Low Pyramid Cover (Mirror Polished)

Cover Opening

- Quantity** 1 2 3 4
- Recycle Escutcheon (Rubber Rosette)
 - Recycle (without Rubber Rosette)

Frame Material

- Powdercoated Mild Steel (See Colour Guide)
- 304 Stainless Steel
- 316 Stainless Steel

Batten Material (See Batten Guide)

65mm x 19mm

- Spotted Gum
 - Enviroslat
 - Anodised Aluminium
 - Powdercoated Aluminium (See Colour Guide)
 - Timber-Look Aluminium - Alpine Ash
 - Timber-Look Aluminium - Mountain Gum
 - Timber-Look Aluminium - Ironbark
- or
- Recycled HDPE Panels - Plain (See Recycled Plastic Colour Guide)
 - Recycled HDPE Panels - Routed Pattern (See Pattern Guide)

Other Options

- Communication Signage (See Signage Guide)
- Dog Bag Dispenser (External Mounted - Model 88737)

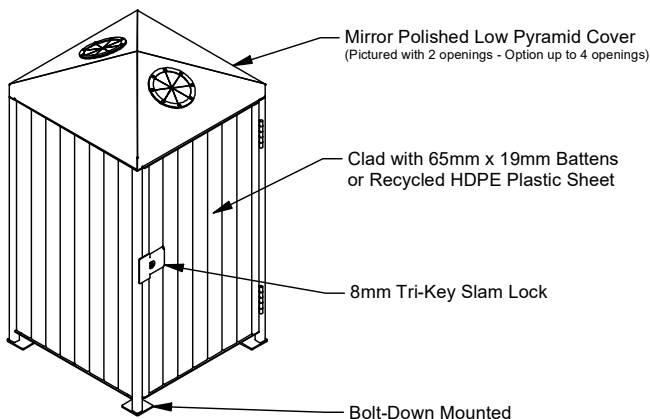
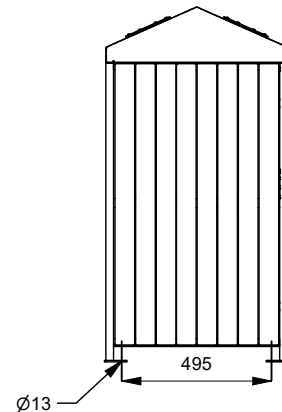
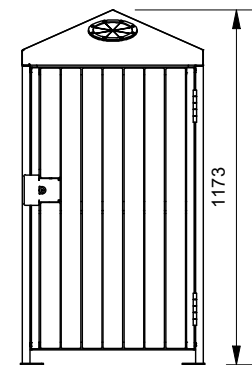
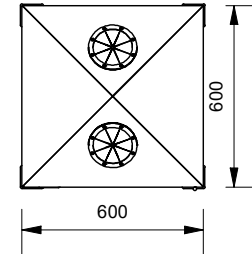

More information:
Go to the website for spec inspiration.

915 - 120lt 900 Series Low Pyramid Cover Bin Surround
<https://draffin.com.au/product/900-series-low-pyramid-bin-surround/>

Colour Guide
<https://draffin.com.au/colour-guide/>

Signage Guide
<https://draffin.com.au/signage-guide/>

Batten Guide
<https://draffin.com.au/batten-guide/>

Stainless Steel Guide
<https://draffin.com.au/stainless-steel-guide/>

Recycled HDPE Plastic Guide
<https://draffin.com.au/recycled-plastic-colour-chart/>

900 Series Low Pyramid Cover 120lt Bin Surround

Model 915 - 900 Series Low Pyramid Cover 120lt Bin Surround



Signage options for 900 Series Bin Surrounds

Sign panel variations including sticker

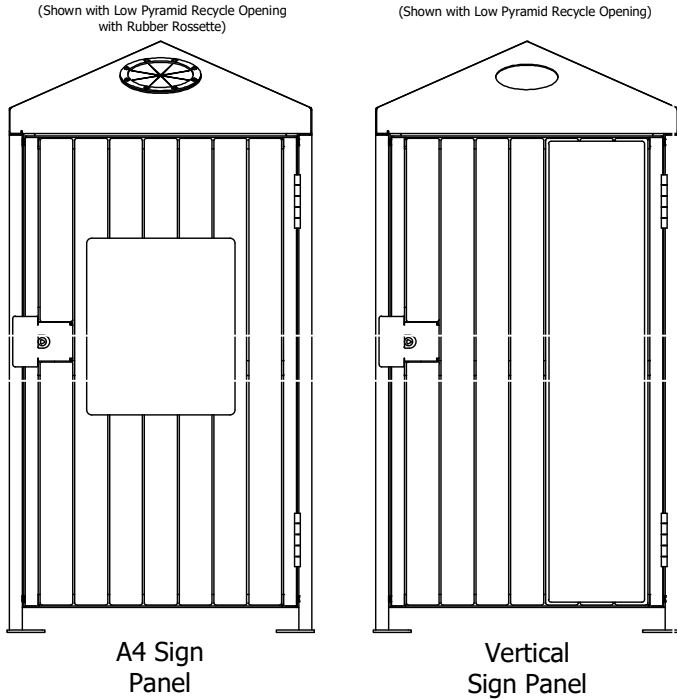

120lt Low Pyramid Cover Openings

Mirror polished 304 grade Stainless Steel cover

- scratch resistant
- easy to clean

Recycle Opening with Rosette
with Heavy-Duty rubber escutcheon

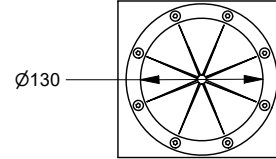

Recycle Opening without Rosette

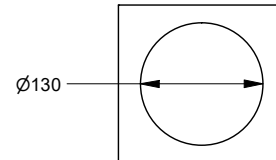

HDPE Recycled Plastic Panels

(In place of battens)

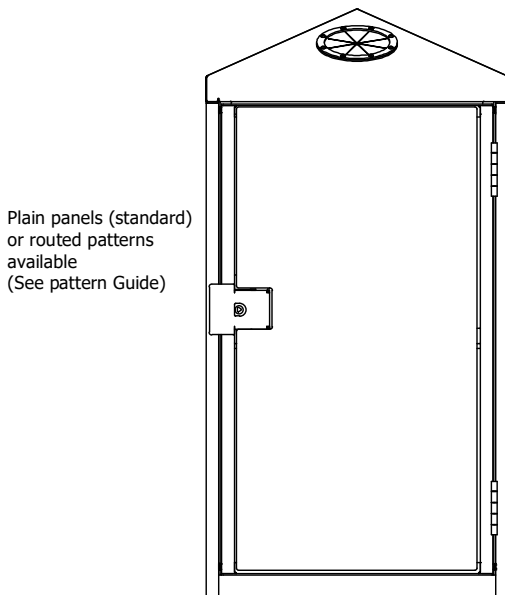

Installation Detail

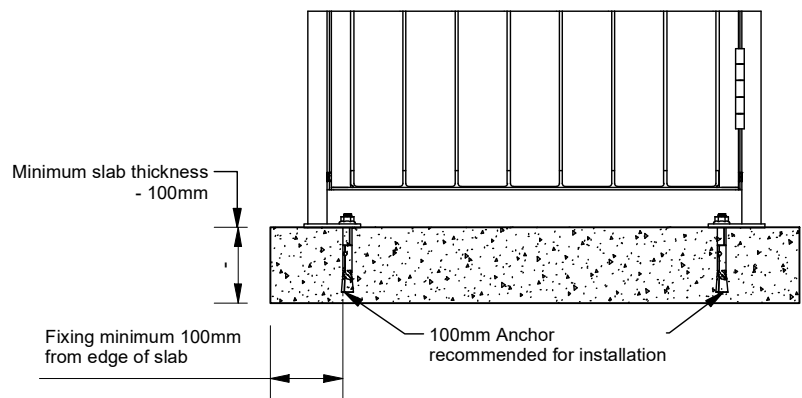

900 Series Low Pyramid Cover 240lt Bin Surround

Model 935 - 900 Series Low Pyramid Cover 240lt Bin Surround

DRAFFIN
Street Furniture



900 series Bin Surrounds with Low Pyramid Covers offer 360 degree access to round openings, primarily used for waste recycling applications. Ideal for high traffic and indoor spaces. The mirror polished stainless steel cover is easy to keep clean. 900 Series Bin Surrounds have a fully welded frame for strength and are clad with battens to soften their appearance.

Size

240lt

Cover Style

Stainless Steel Low Pyramid Cover (Mirror Polished)

Cover Opening

Quantity 1 2 3 4

Recycle Escutcheon (Rubber Rosette)

Recycle (without Rubber Rosette)

Frame Material

Powdercoated Mild Steel (See Colour Guide)

304 Stainless Steel

316 Stainless Steel

Batten Material (See Batten Guide)

65mm x 19mm

Spotted Gum

Enviroslat

Anodised Aluminium

Powdercoated Aluminium (See Colour Guide)

Timber-Look Aluminium - Alpine Ash

Timber-Look Aluminium - Mountain Gum

Timber-Look Aluminium - Ironbark

or

Recycled HDPE Panels - Plain (See Recycled Plastic Colour Guide)

Recycled HDPE Panels - Routed Pattern (See Pattern Guide)

Other Options

Communication Signage (See Signage Guide)

Dog Bag Dispenser (External Mounted - Model 88737)

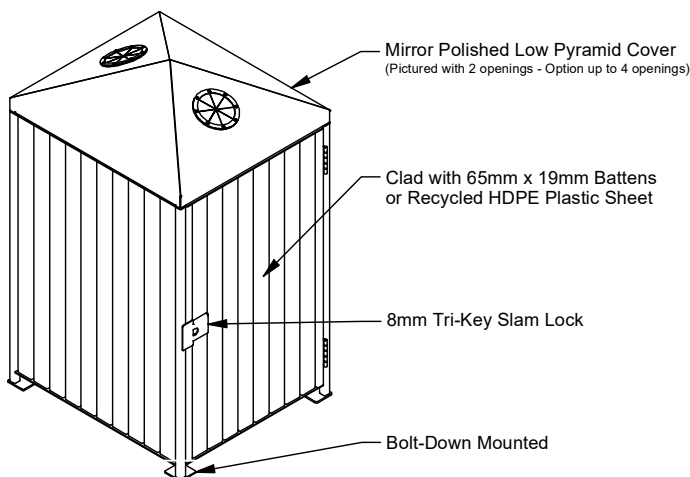
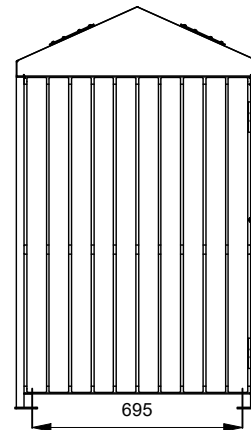
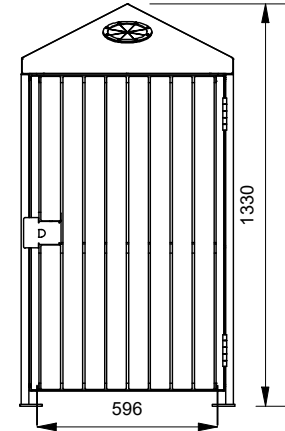
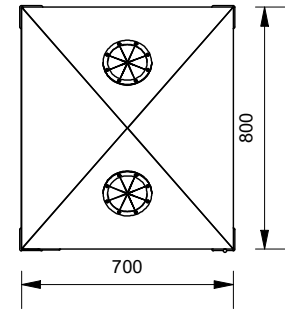

More information:
Go to the website for spec inspiration.

935 - 240lt 900 Series Low Pyramid Cover Bin Surround
<https://draffin.com.au/product/900-series-low-pyramid-bin-surround/>

Colour Guide
<https://draffin.com.au/colour-guide/>

Signage Guide
<https://draffin.com.au/signage-guide/>

Batten Guide
<https://draffin.com.au/batten-guide/>

Stainless Steel Guide
<https://draffin.com.au/stainless-steel-guide/>

Recycled HDPE Plastic Guide
<https://draffin.com.au/recycled-plastic-colour-chart/>

900 Series Low Pyramid Cover 240lt Bin Surround

Model 935 - 900 Series Low Pyramid Cover 240lt Bin Surround



Signage options for 900 Series Bin Surrounds

Sign panel variations including sticker

(Shown with Low Pyramid Cover Recycle Opening with Rubber Rosette)

(Shown with Low Pyramid Cover Recycle Opening)

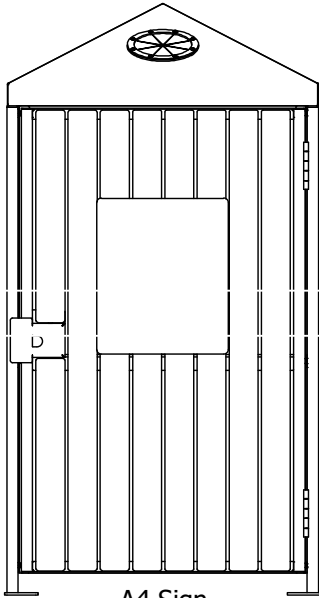

A4 Sign Panel

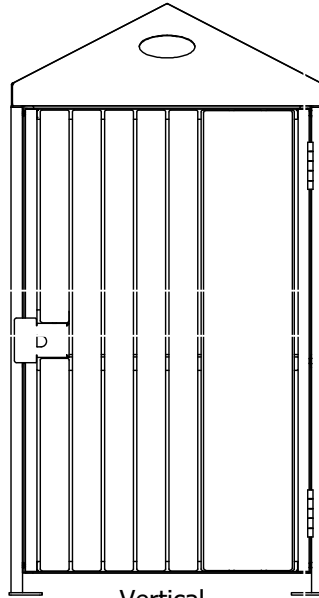

Vertical Sign Panel

240lt Low Pyramid Cover Openings

Mirror polished 304 grade Stainless Steel cover

- scratch resistant
- easy to clean

Recycle Opening with Rosette
with Heavy-Duty rubber escutcheon

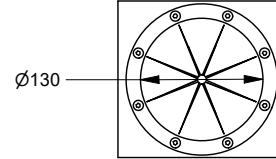

Recycle Opening without Rosette

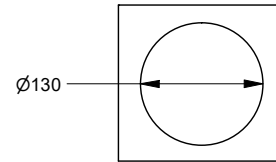

HDPE Recycled Plastic Panels

(In place of battens)

Plain panels (standard)
or routed patterns
available
(See pattern Guide)

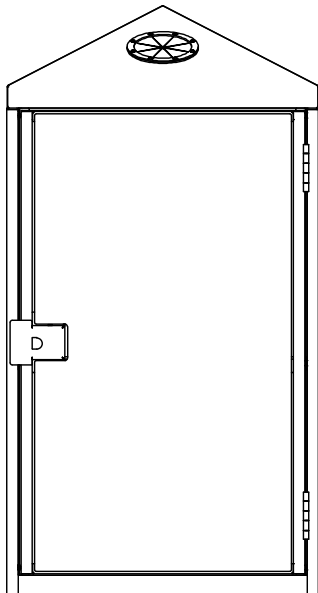

Installation Detail

