

# 900 Series Flat Cover 120lt Bin Surround

Model 913 - 900 Series Flat Cover 120lt Bin Surround

**DRAFFIN**  
Street Furniture



900 series Bin Surrounds with Flat Covers offer 360 degree access to the opening. Ideal for high traffic and indoor spaces. The mirror polished stainless steel cover offers a large opening that is easy to keep clean. 900 Series Bin Surrounds have a fully welded frame for strength and are clad with battens to soften their appearance.

#### Size

- 120lt

#### Cover Style

- Stainless Steel Flat Cover

#### Canopy Material

- 304 Stainless Steel (Mirror Polished)
- 316 Stainless Steel (Mirror Polished)

#### Frame Material

- Powdercoated Mild Steel (See Colour Guide)
- 304 Stainless Steel
- 316 Stainless Steel

#### Batten Material (See Batten Guide)

65mm x 19mm

- Spotted Gum
  - Enviroslat
  - Anodised Aluminium
  - Powdercoated Aluminium (See Colour Guide)
  - Timber-Look Aluminium - Alpine Ash
  - Timber-Look Aluminium - Mountain Gum
  - Timber-Look Aluminium - Ironbark
- or
- Recycled HDPE Panels - Plain (See Recycled Plastic Colour Guide)
  - Recycled HDPE Panels - Routed Pattern (See Pattern Guide)

#### Other Options

- Communication Signage (See Signage Guide)
- Dog Bag Dispenser (External Mounted - Model 88737)

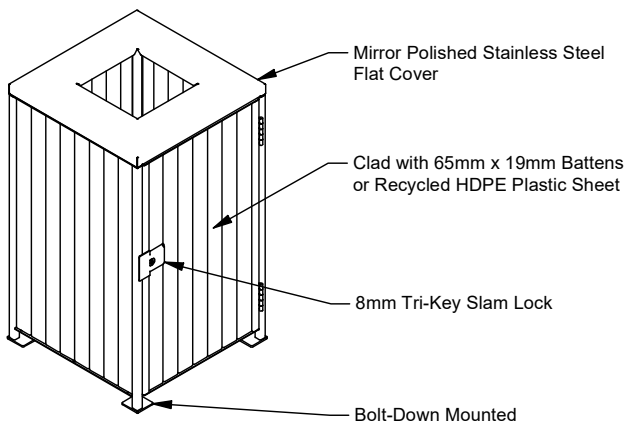
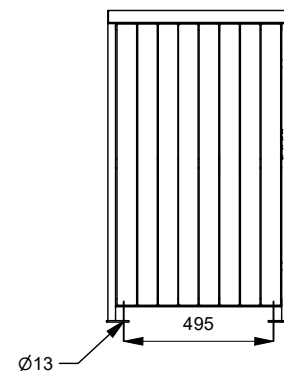
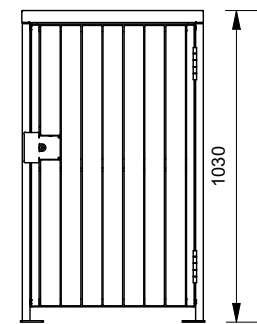
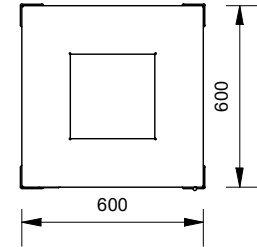

More information:  
Go to the website for spec inspiration.

**913 - 120lt 900 Series Flat Cover Bin Surround**  
<https://draffin.com.au/product/900-series-flat-cover-bin-surround/>

Colour Guide  
<https://draffin.com.au/colour-guide/>

Signage Guide  
<https://draffin.com.au/signage-guide/>

Batten Guide  
<https://draffin.com.au/batten-guide/>

Stainless Steel Guide  
<https://draffin.com.au/stainless-steel-guide/>

Recycled HDPE Plastic Guide  
<https://draffin.com.au/recycled-plastic-colour-chart/>

# 900 Series Flat Cover 120lt Bin Surround

Model 913 - 900 Series Flat Cover 120lt Bin Surround



## Signage options for 900 Series Bin Surrounds

Sign panel variations including sticker

## 120lt Flat Cover Opening

Mirror polished 304 grade Stainless Steel cover

- scratch resistant
- easy to clean

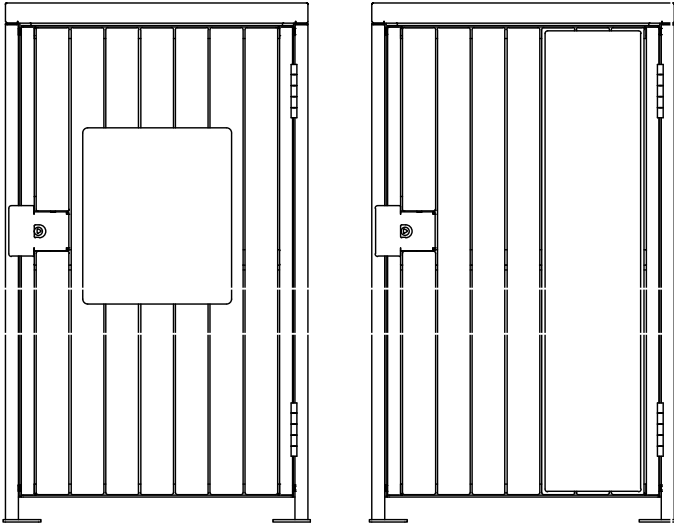

A4 Sign  
Panel

Vertical  
Sign Panel

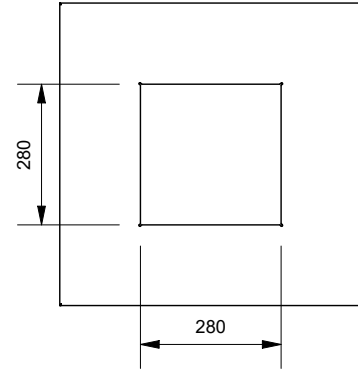

## HDPE Recycled Plastic Panels

(In place of battens)

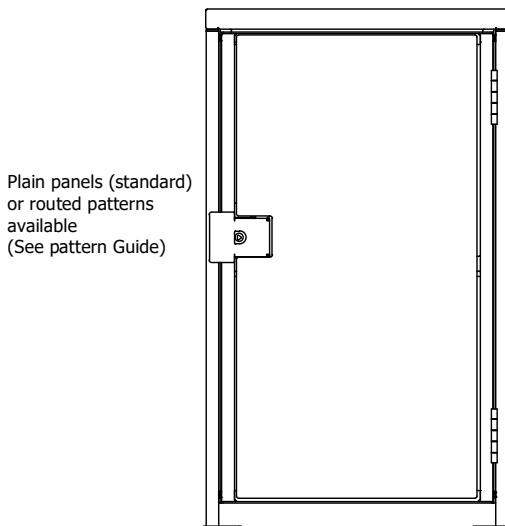

Plain panels (standard)  
or routed patterns  
available  
(See pattern Guide)

## Installation Detail

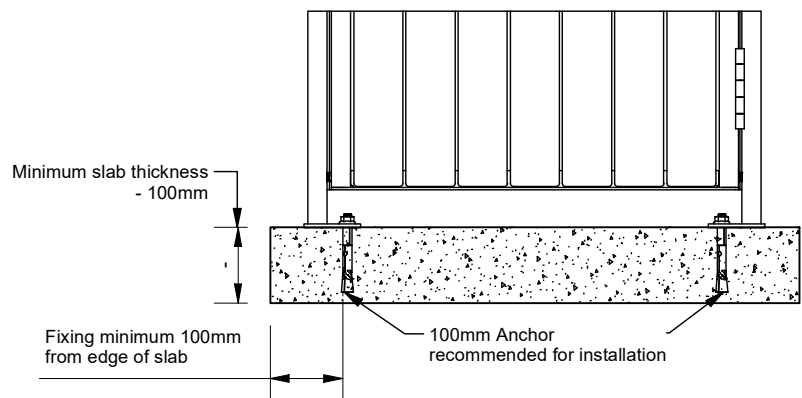

Minimum slab thickness  
- 100mm

Fixing minimum 100mm  
from edge of slab

100mm Anchor  
recommended for installation

# 900 Series Flat Cover 240lt Bin Surround

Model 933 - 900 Series Flat Cover 240lt Bin Surround

**DRAFFIN**  
Street Furniture



900 series Bin Surrounds with Flat Covers offer 360 degree access to the opening. Ideal for high traffic and indoor spaces. The mirror polished stainless steel cover offers a large opening that is easy to keep clean. 900 Series Bin Surrounds have a fully welded frame for strength and are clad with battens to soften their appearance.

#### Size

- 240lt

#### Cover Style

- Stainless Steel Flat Cover

#### Canopy Material

- 304 Stainless Steel (Mirror Polished)
- 316 Stainless Steel (Mirror Polished)

#### Frame Material

- Powdercoated Mild Steel (See Colour Guide)
- 304 Stainless Steel
- 316 Stainless Steel

#### Batten Material (See Batten Guide)

65mm x 19mm

- Spotted Gum
  - Enviroslat
  - Anodised Aluminium
  - Powdercoated Aluminium (See Colour Guide)
  - Timber-Look Aluminium - Alpine Ash
  - Timber-Look Aluminium - Mountain Gum
  - Timber-Look Aluminium - Ironbark
- or
- Recycled HDPE Panels - Plain (See Recycled Plastic Colour Guide)
  - Recycled HDPE Panels - Routed Pattern (See Pattern Guide)

#### Other Options

- Communication Signage (See Signage Guide)
- Dog Bag Dispenser (External Mounted - Model 88737)

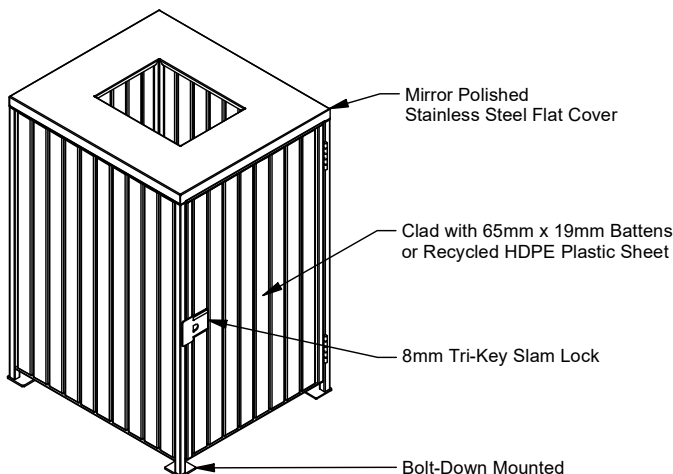
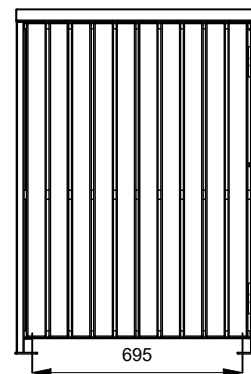
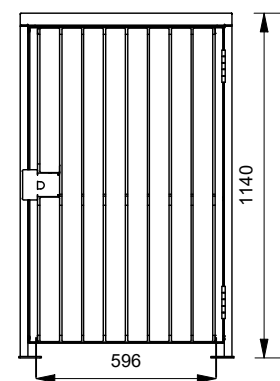
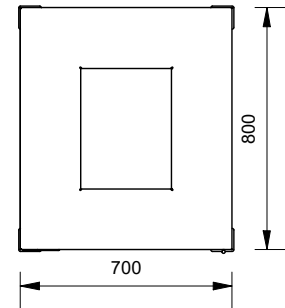

More information:  
Go to the website for spec inspiration.

**933 - 240lt 900 Series Flat Cover Bin Surround**  
<https://draffin.com.au/product/900-series-flat-cover-bin-surround/>

Colour Guide  
<https://draffin.com.au/colour-guide/>

Signage Guide  
<https://draffin.com.au/signage-guide/>

Batten Guide  
<https://draffin.com.au/batten-guide/>

Stainless Steel Guide  
<https://draffin.com.au/stainless-steel-guide/>

Recycled HDPE Plastic Guide  
<https://draffin.com.au/recycled-plastic-colour-chart/>

# 900 Series Flat Cover 240lt Bin Surround

Model 933 - 900 Series Flat Cover 240lt Bin Surround



## Signage options for 900 Series Bin Surrounds

Sign panel variations including sticker

## 240lt Flat Cover Opening

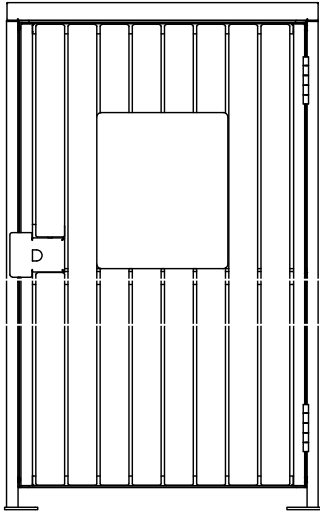

A4 Sign  
Panel

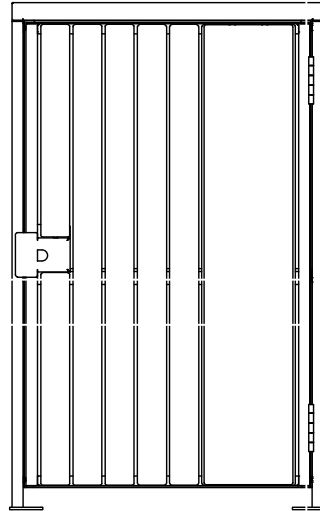

Vertical  
Sign Panel

Mirror polished 304 grade Stainless Steel cover

- scratch resistant
- easy to clean

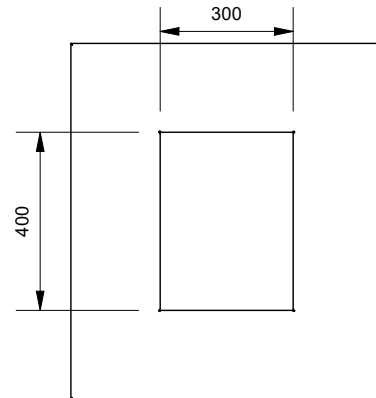

## HDPE Recycled Plastic Panels

(In place of battens)

Plain panels (standard)  
or routed patterns  
available  
(See pattern Guide)

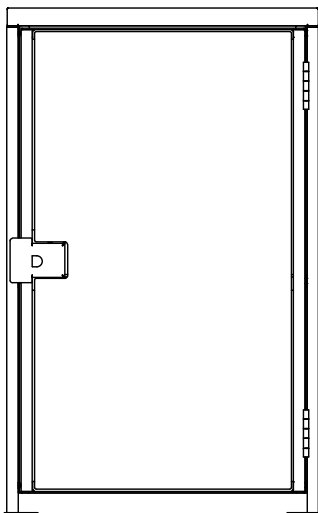

## Installation Detail

