

888 Infinity Series Flat Cover Bin Surround

Model 88801 - 120lt Infinity Series Flat Cover Bin Surround

DRAFFIN
Street Furniture



*Registered design 201810464.
*Patent no 2018900173

120lt Model

The Infinity Series Flat Cover Bin Surround is ideal for indoor applications with 360 degree access to the opening on top. Infinity Series offers the largest standard option list of any bin enclosure in Australia to ensure Infinity Series can be specified for use in almost any application.

Size

- 120lt

Cover Style

- Polished 316 Stainless Steel Flat Cover

Frame Material

- Powdercoated Mild Steel (See Colour Guide)
- 304 Stainless Steel
- 316 Stainless Steel

Door and Rear Panel Material

- Powdercoated Mild Steel (See Colour Guide)
- 304 Stainless Steel
- 316 Stainless Steel

Side Panel Material

- Powdercoated Mild Steel (See Colour Guide)
- 304 Stainless Steel
- 316 Stainless Steel

Side Panel Battens (optional) (See Batten Guide)

- None
- Spotted Gum Battens
- Enviroslat Composite Battens
- Timber-Look Aluminium Battens

Lock System

- Cam Lock
- Magnet Latch
- Both

Other Options

- Communication Signage (See Signage Guide)
- Perforations (See Perforation Guide)
- Ashtray Module
- Laser Cut Logo
- Logo Backing Plates

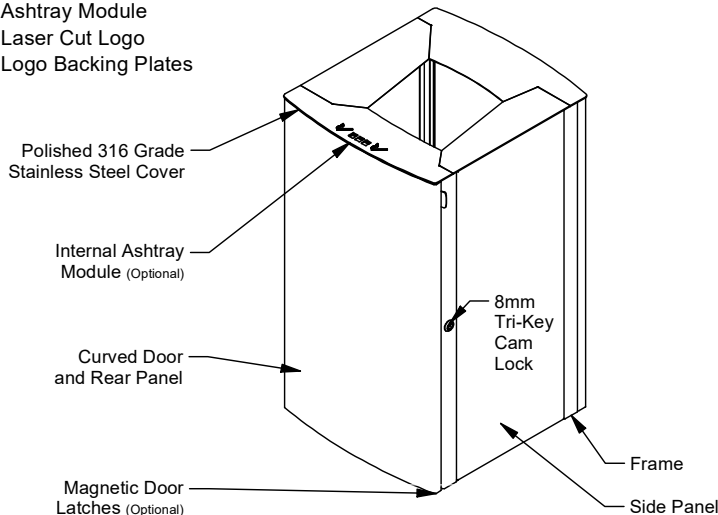
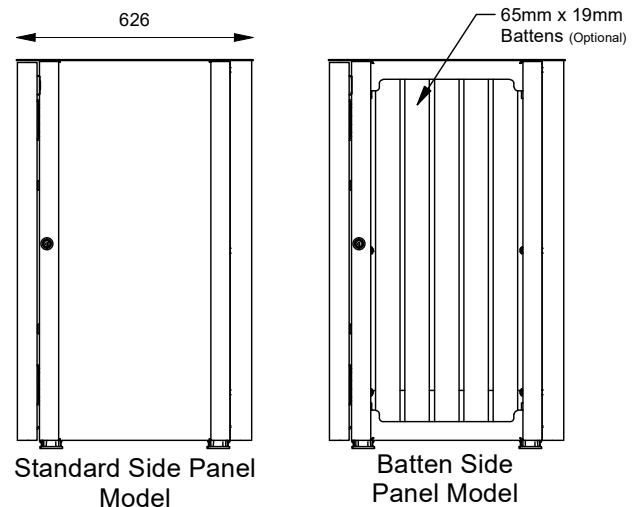
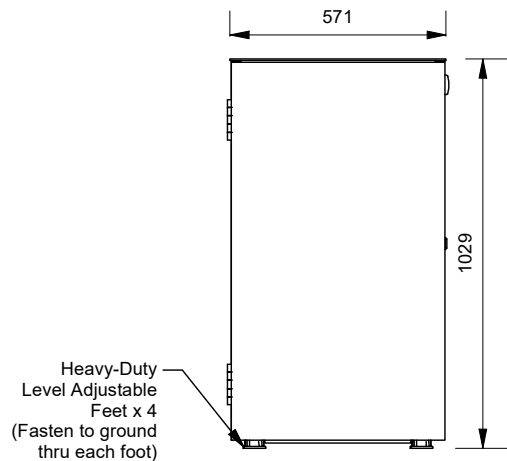
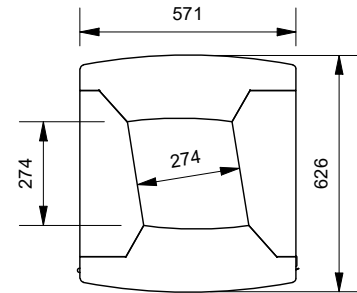

More information:
Go to the website for spec inspiration.

88801 - 120lt 888 Infinity Series Flat Cover Bin Surround
<https://draffin.com.au/product/infinity-series-bin-surround-flat-cover/>

Colour Guide
<https://draffin.com.au/colour-guide/>

Perforation Guide
<https://draffin.com.au/perforation-patterns/>

Signage Guide
<https://draffin.com.au/signage-guide/>

Batten Guide
<https://draffin.com.au/batten-guide/>

Stainless Steel Guide
<https://draffin.com.au/stainless-steel-guide/>

888 Infinity Series Flat Cover Bin Surround

Model 88811 - 240lt Infinity Series Flat Cover Bin Surround

DRAFFIN
Street Furniture



*Registered design 201810464.
*Patent no 2018900173

240lt Model

The Infinity Series Flat Cover Bin Surround is ideal for indoor applications with 360 degree access to the opening on top. Infinity Series offers the largest standard option list of any bin enclosure in Australia to ensure Infinity Series can be specified for use in almost any application.

Size

- 240lt

Cover Style

- Polished 316 Stainless Steel Flat Cover

Frame Material

- Powdercoated Mild Steel (See Colour Guide)
- 304 Stainless Steel
- 316 Stainless Steel

Door and Rear Panel Material

- Powdercoated Mild Steel (See Colour Guide)
- 304 Stainless Steel
- 316 Stainless Steel

Side Panel Material

- Powdercoated Mild Steel (See Colour Guide)
- 304 Stainless Steel
- 316 Stainless Steel

Side Panel Battens (optional) (See Batten Guide)

- None
- Spotted Gum Battens
- Enviroslat Composite Battens
- Timber-Look Aluminium Battens

Lock System

- Cam Lock
- Magnet Latch
- Both

Other Options

- Communication Signage
- Perforations (See Perforation Guide)
- Ashtray Module
- Laser Cut Logo (See Signage Guide)
- Logo Backing Plates

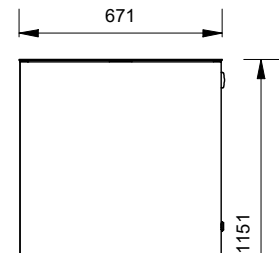
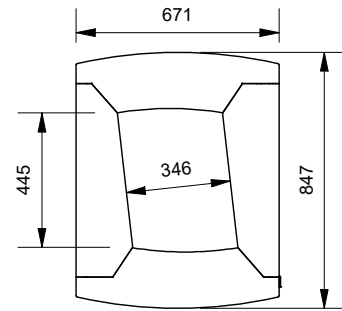
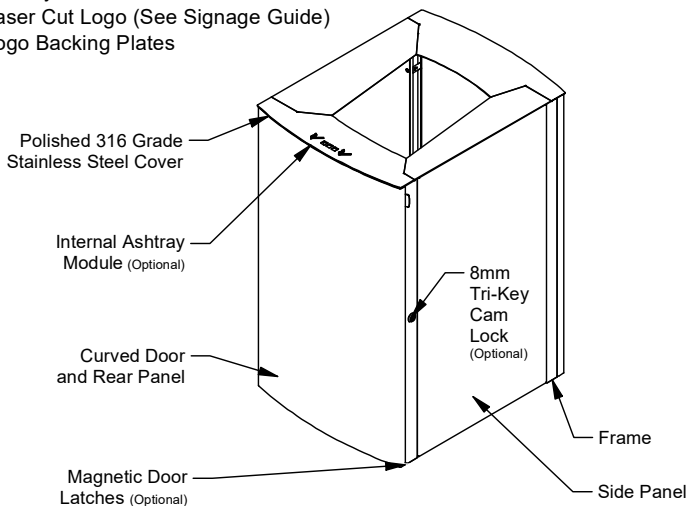

Heavy-Duty
Level Adjustable
Feet x 4
(Fasten to ground
thru each foot)

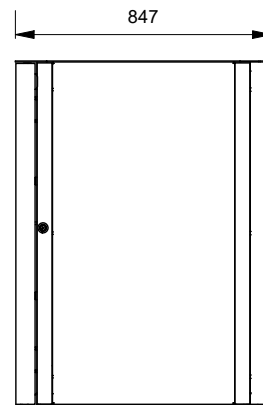

Standard Side Panel Model

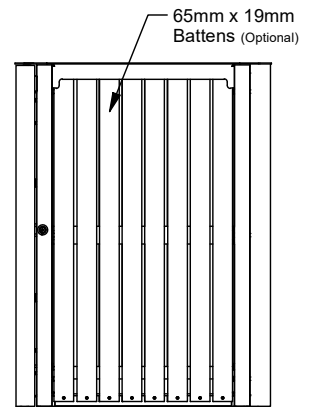

Batten Side Panel Model

More information:
Go to the website for spec inspiration.

88811 - 240lt 888 Infinity Series Flat Cover Bin Surround
<https://draffin.com.au/product/infinity-series-bin-surround-flat-cover/>

Colour Guide
<https://draffin.com.au/colour-guide/>

Perforation Guide
<https://draffin.com.au/perforation-patterns/>

Signage Guide
<https://draffin.com.au/signage-guide/>

Batten Guide
<https://draffin.com.au/batten-guide/>

Stainless Steel Guide
<https://draffin.com.au/stainless-steel-guide/>