

Wandin Modular Suite

Architectural Guide

■ DRAFFIN ■
Street Furniture



The Wandin Suite consists of an array of straight and curved commercial grade outdoor furniture designed for both standalone and modular placement. When joined end to end in almost any combination, unique profiles can be created. And with all modular sizes and shapes available as standard, Wandin furniture will fit into more existing and new project spaces.

A cross laid uniform batten is used over heavy-duty sub-frames combined with several mounting options. And the suite is also complimented with concrete benches that mimic the Wandin profile.

Mix and Match to create your unique combination of Wandin outdoor furniture.

Wandin Modular Suite Guide

How to Specify Wandin Modules



Wandin furniture is modular in design. All straight and curved seating is designed for both standalone placement and for end to end placement to form longer seating in any configuration. End to end placement allows for unique profiles or winding and snaking shapes in both bench and seat formats. Armrests can also be specified for benches and seats on the ends and some models also allow for middle armrest placement. Both **major** and **minor** modules can be found in this guide. **Major** modules (on this page) provide larger profiles to create significant shaping of Wandin furniture, while **minor** modules (Pg.6) introduce junctions and tighter corner shapes.

Standard Major Module Profiles

Modules represent the standard space per model profile. Whether a seat or bench in any configuration, Wandin products can be placed end to end to create unique shapes. Bench height concrete modules also share these dimensions for placement alongside any Wandin bench or seat.

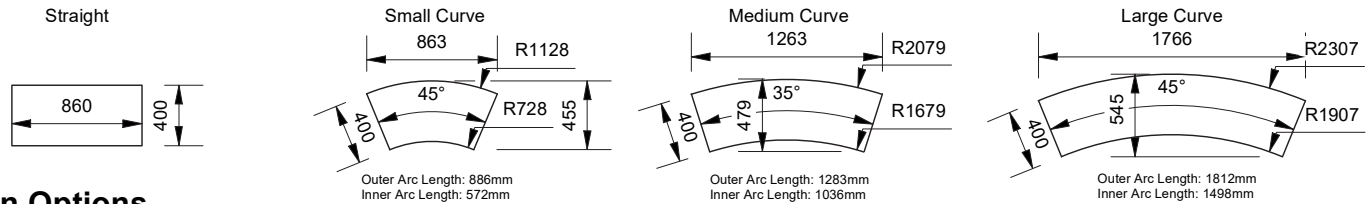

Batten Options

Wandin furniture all use a uniform batten profile of **405mm x 40mm x 30mm**. Batten materials include:

- 1) Spotted Gum Timber 2) Enviroslat Composite 3) Aluminium (Anodised, Powdercoated, Timber-Look)



*Uniform Batten Profile - 405mm x 40mm x 30mm

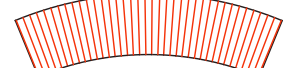
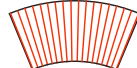

Backrest Options

The same uniform batten profile is used on backrests. Backrest placement on curved furniture will determine if the seat is concave or convex configuration. On the two larger curved modules you can opt for a full back or half back on the left or the right.

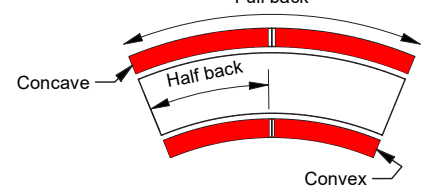
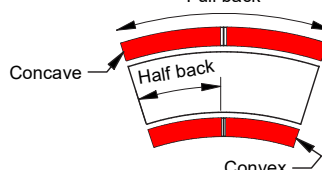
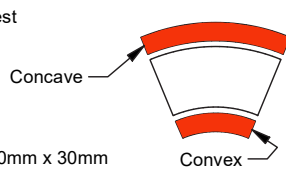
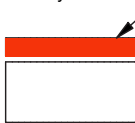

*Uniform Batten Profile - 405mm x 40mm x 30mm

Armrest Options

Add armrests to benches or seats where required

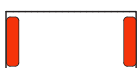

- Left · Right
- Both · None



- Left · Right
- Both · None



- Left · Middle · Right
- Two · None

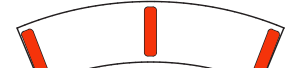

- Left · Middle · Right
- Two · None

Section Options

Seat Height - 430mm

Section options represent the mounting options available for Wandin Seats and Benches.

Bolt Down (Post Mount)



Inground (Post Mount)

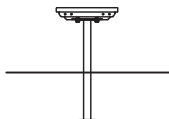

Concrete Plinth Mount



(Plinth Sold Separately)

Concrete End Mount



(Concrete Benches Sold Separately)

Full Concrete



(Bench Only)

Fin Leg (Bolt Down)



Flat Bar Leg (Bolt Down)



Freestanding



Examples

(using options above)

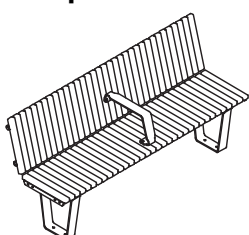

2 x Straight Modules with Backrests
1 x Armrest (centrally placed)
Flat Bar Legs

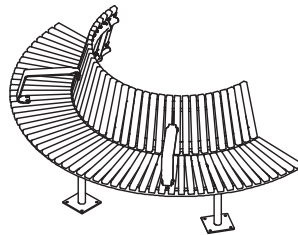

4 x Small Curved Modules with Backrests
2 x Armrest (placed between modules)
Bolt Down Legs

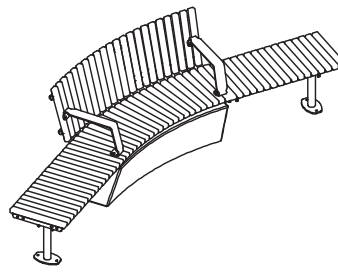

1 x Medium Curved Module, Full Backrest
2 x Straight Modules (one either side)
2 x Armrests on Curved Module
Plinth Mount & Bolt Down Legs

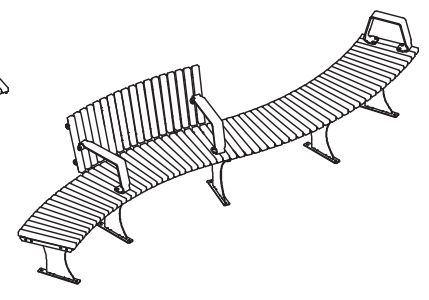

1 x Large Curved Bench Module (1 x armrest)
2 x Armrests on Curved Halfback Module
Fin Legs

Wandin Modular Suite Guide

How to Specify Wandin Modules

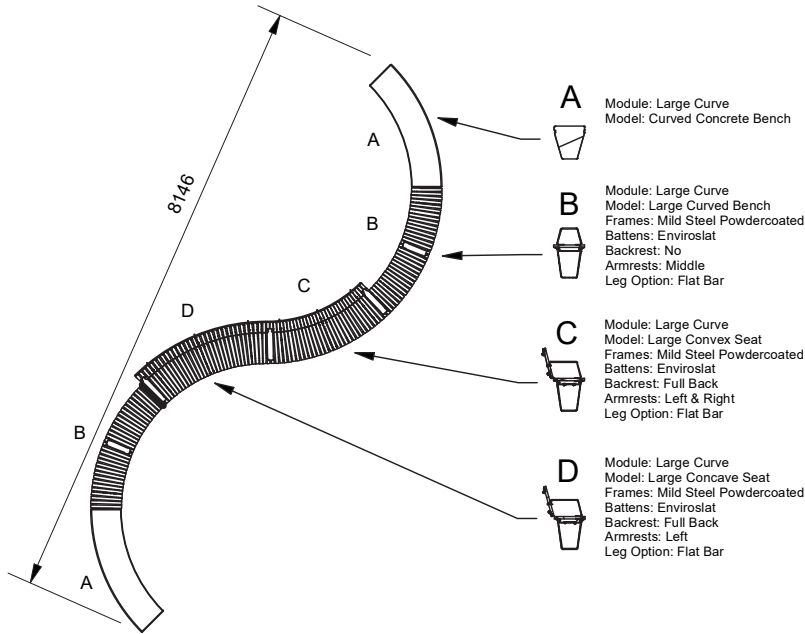

A Module: Large Curve
Model: Curved Concrete Bench

B Module: Large Curve
Model: Large Curved Bench
Frames: Mild Steel Powdercoated
Battens: Enviroslat
Backrest: No
Armrests: Middle
Leg Option: Flat Bar

C Module: Large Curve
Model: Large Convex Seat
Frames: Mild Steel Powdercoated
Battens: Enviroslat
Backrest: Full Back
Armrests: Left & Right
Leg Option: Flat Bar

D Module: Large Curve
Model: Large Concave Seat
Frames: Mild Steel Powdercoated
Battens: Enviroslat
Backrest: Full Back
Armrests: Left
Leg Option: Flat Bar

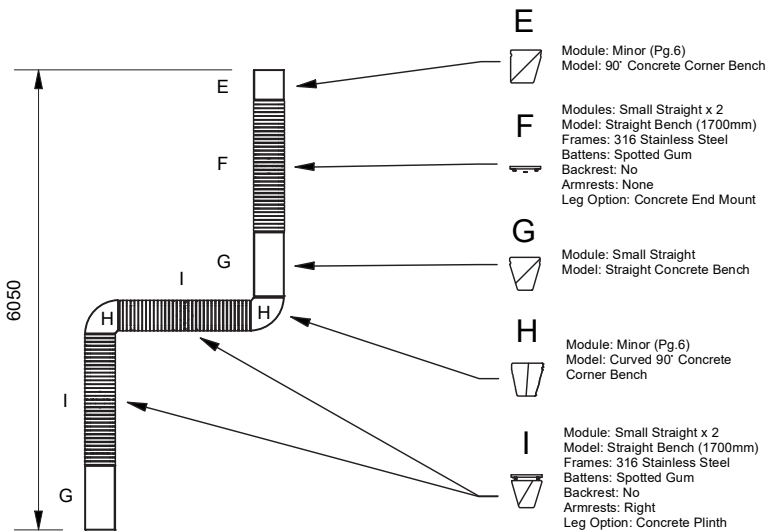

E Module: Minor (Pg.6)
Model: 90° Concrete Corner Bench

F Modules: Small Straight x 2
Model: Straight Bench (1700mm)
Frames: 316 Stainless Steel
Battens: Spotted Gum
Backrest: No
Armrests: None
Leg Option: Concrete End Mount

G Module: Small Straight
Model: Straight Concrete Bench

H Module: Minor (Pg.6)
Model: Curved 90° Concrete Corner Bench

I Module: Small Straight x 2
Model: Straight Bench (1700mm)
Frames: 316 Stainless Steel
Battens: Spotted Gum
Backrest: No
Armrests: Right
Leg Option: Concrete Plinth

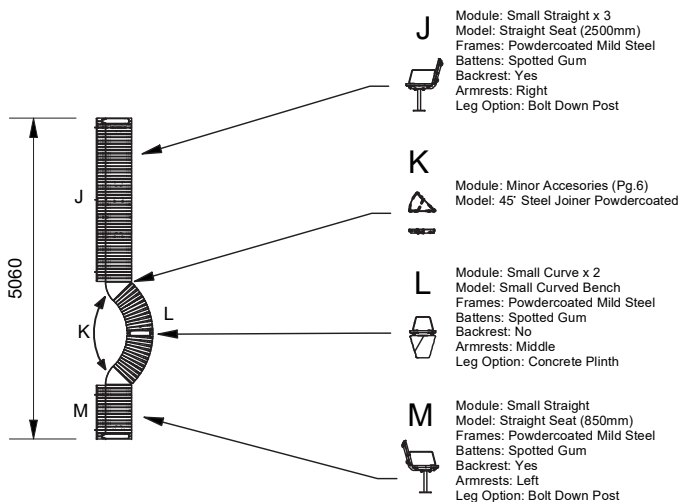

J Module: Small Straight x 3
Model: Straight Seat (2500mm)
Frames: Powdercoated Mild Steel
Battens: Spotted Gum
Backrest: Yes
Armrests: Right
Leg Option: Bolt Down Post

K Module: Minor Accessories (Pg.6)
Model: 45° Steel Joiner Powdercoated

L Module: Small Curve x 2
Model: Small Curved Bench
Frames: Powdercoated Mild Steel
Battens: Spotted Gum
Backrest: No
Armrests: Middle
Leg Option: Concrete Plinth

M Module: Small Straight
Model: Straight Seat (850mm)
Frames: Powdercoated Mild Steel
Battens: Spotted Gum
Backrest: Yes
Armrests: Left
Leg Option: Bolt Down Post



Wandin Module Options

Major Seat Modules



Typical Seat Profiles

Major Module Type

- Large Curve
- Medium Curve
- Small Curve
- Straight

Armrests

- None
- Left
- Middle (Medium and Large Curve only)
- Right

Batten Material

405mm x 40mm x 30mm

- Spotted Gum
- Enviroslat
- Anodised Aluminium
- Powdercoated Aluminium
- Timber-Look Aluminium (3 varieties available)

Frame Material

- Galvanised Mild Steel
- Powdercoated - Galvanised Mild Steel (See Colour Guide)
- 304 Stainless Steel
- 316 Stainless Steel

Leg Mount Type

- Bolt-Down Post
- Inground Post
- Fin Leg
- Flat Bar Leg
- Freestanding
- Concrete Plinth
- End Mount Plate (to concrete bench)

Seat Type

- Seat with Full Backrest
 - Seat with Half Backrest - Left
 - Seat with Half Backrest - Right
- (Half backrest options - Medium and Large Curve Modules Only)

*↔ Depending on Furniture Layout, Leg Spacing Determined by Draffin

Bolt Down Post

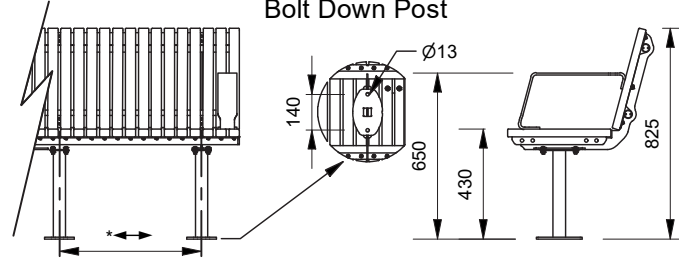

Inground Post

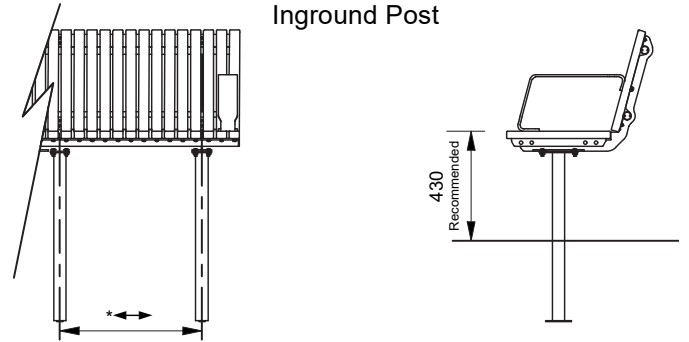

Fin Leg

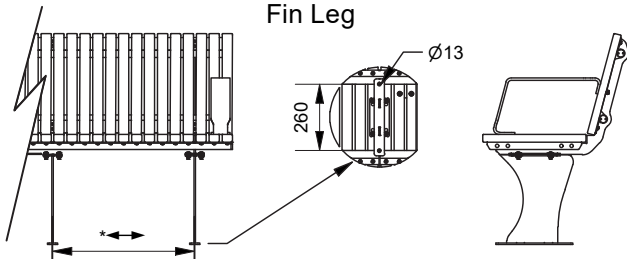

Flat Bar Leg

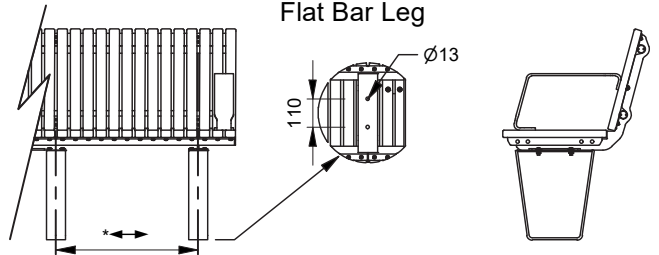

Freestanding

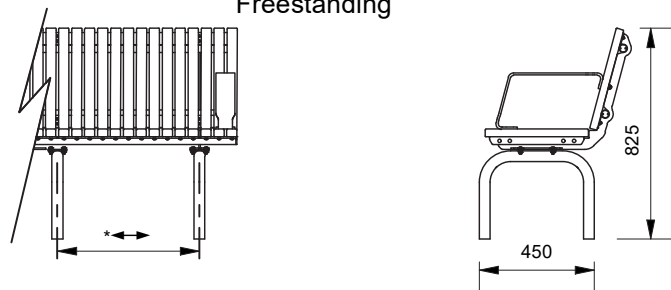

Plinth Mount

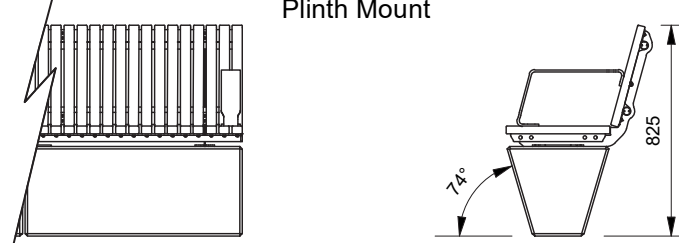

Concrete Bench End Mount (Plate)

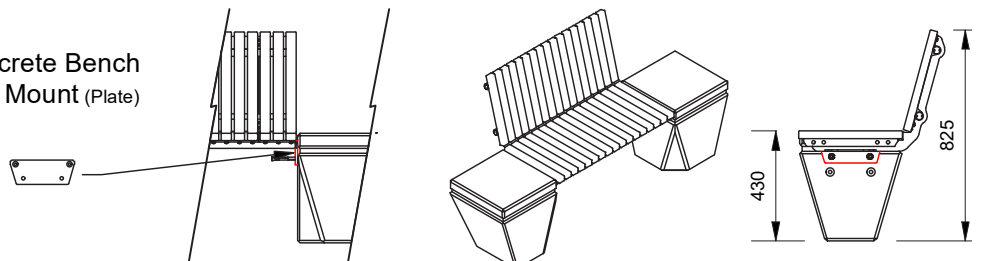

Wandin Module Options

Major Bench Modules



Typical Bench Profiles

Major Module Type

- Large Curve
- Medium Curve
- Small Curve
- Straight

Bench Type

- Full Concrete Bench (No Battens)
- Battened Bench

Armrests (Not available for full concrete benches)

- None
- Left
- Middle (Medium and Large Curve only)
- Right

Batten Material

- 405mm x 40mm x 30mm
- Spotted Gum
- Enviroslat
- Anodised Aluminium
- Powdercoated Aluminium
- Timber-Look Aluminium (3 varieties available)

Frame Material

- Galvanised Mild Steel
- Powdercoated - Galvanised Mild Steel (See Colour Guide)
- 304 Stainless Steel
- 316 Stainless Steel

Leg Mount Type

- Bolt-Down Post
- Inground Post
- Fin Leg
- Flat Bar Leg
- Freestanding
- Concrete Plinth
- End Mount Plate (to concrete bench)

*↔ Depending on Furniture Layout, Leg Spacing Determined by Draffin

Bolt Down Post

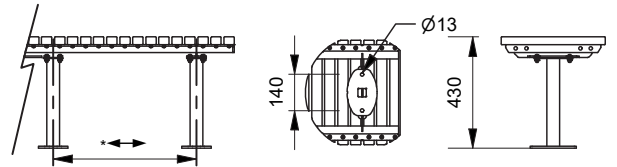

Inground Post

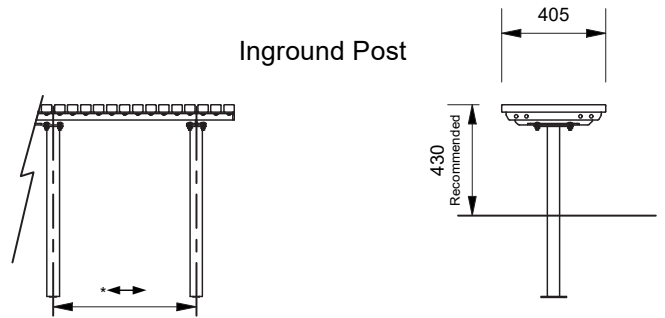

Fin Leg

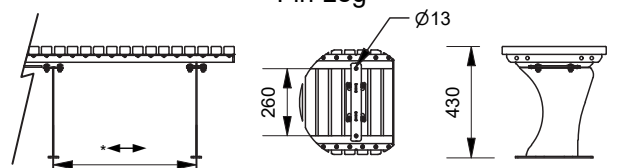

Flat Bar Leg

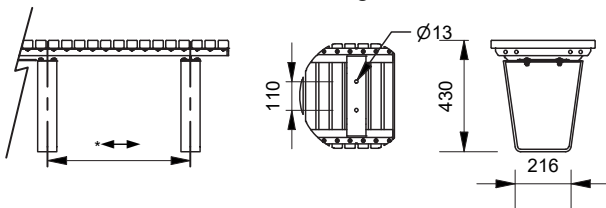

Freestanding



Plinth Mount

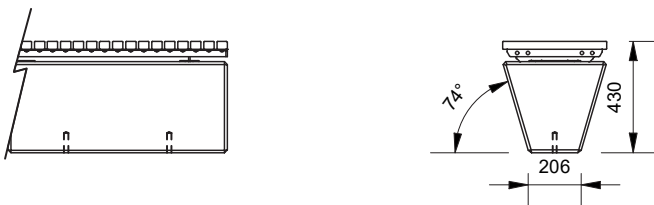

Concrete Bench

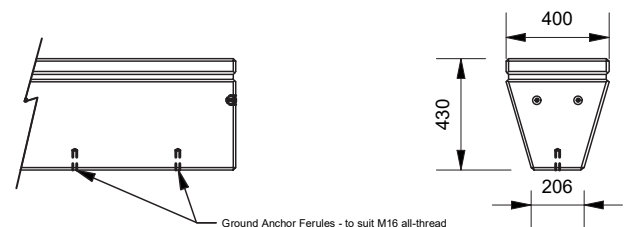

Concrete Bench End Mount (Plate)

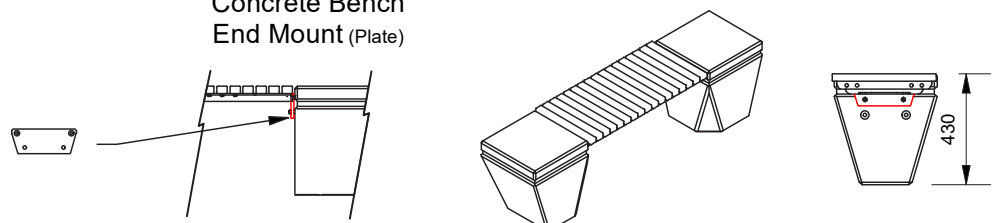

Wandin Module Options

Minor Bench Modules



Typical Minor Bench Profiles

* Depending on Furniture Layout, Steel Leg Spacing Determined by Draffin

Minor Module Type

- Concrete 90° Corner Bench
- Concrete 90° Corner Plinth (Mount option for Wandin frames)
- Concrete 4 way Junction Bench
- Concrete 90° Curved Corner Bench
- Steel 45° Corner Bench
- Steel 90° Corner Bench
- Battened 90° Corner Bench "Connector"

Steel 45° Corner Bench (30329)

W1X/SC45

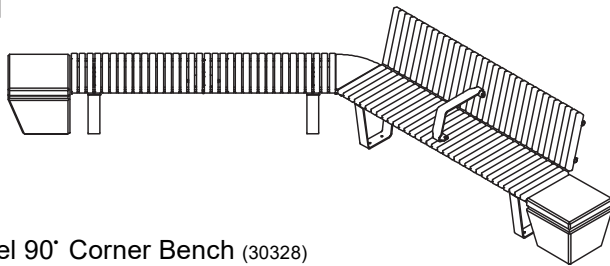
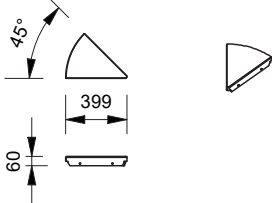

Steel 90° Corner Bench (30328)

W1X/SC90

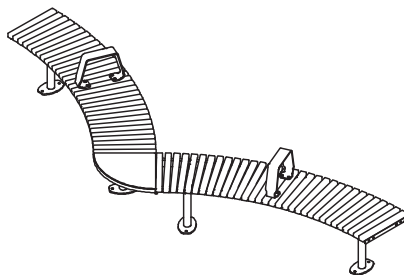
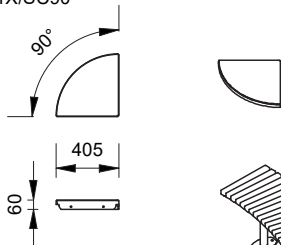

Battened 90° Corner Bench "Connector" (11S/CNR)

W1X/CNR

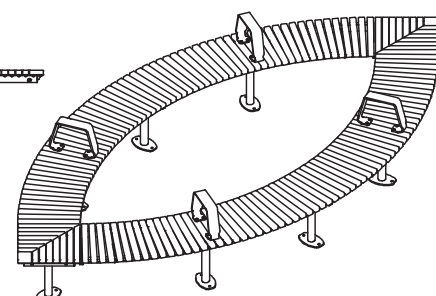
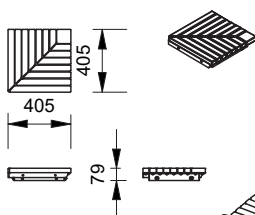

Concrete 90° Corner Bench

32401

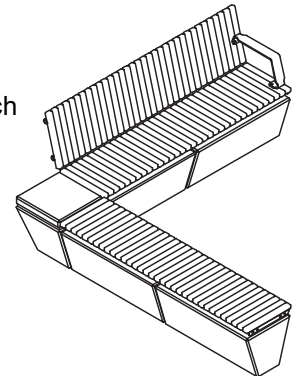
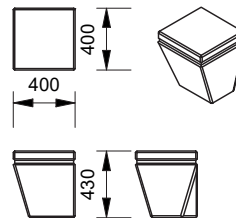

Concrete 90° Corner Plinth

32400 (Mount Option for Wandin Frames)

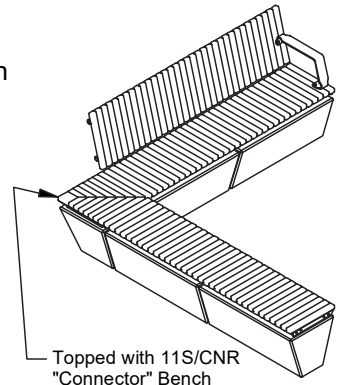
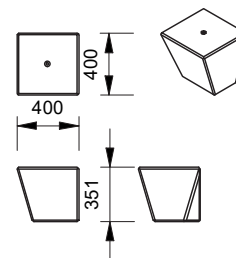

Topped with 11S/CNR
"Connector" Bench

Concrete 4 way Junction Bench

32415

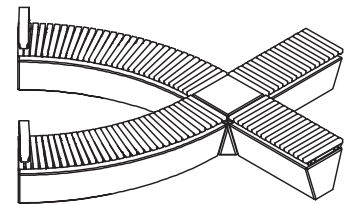
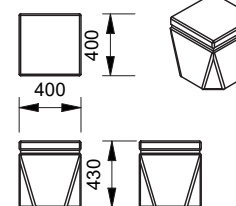

Concrete 90° Curved Corner Bench

32402

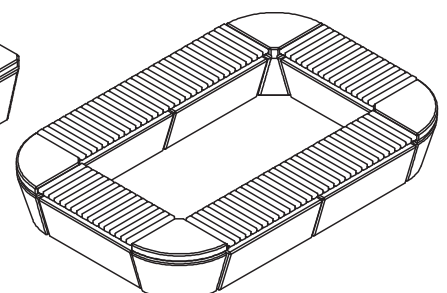
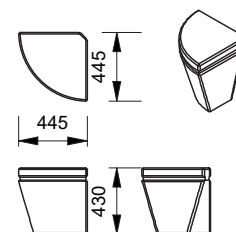

Wandin Mounting Options

Module Mounting and Installation



Lifting Concrete Modules

Standard lifting lugs are supplied on all major concrete modules.

- Plinth Modules - Located on top (Hidden under frames)
- Bench Height Modules - Located on ends

If required, a matching grout can be supplied to hide lugs or use Sikaflex PRO+ or equivalent.

No lifting lugs are provided on minor concrete modules. Use an appropriate sling to move minor modules into place.

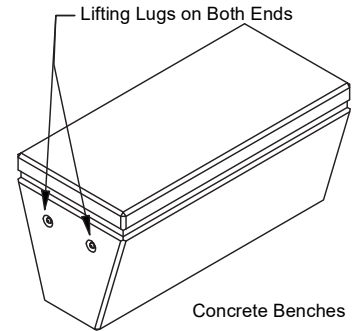
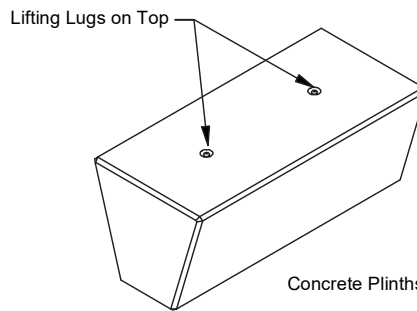

Concrete Module Placement

When placing concrete modules together, a 10mm gap is required to ensure correct module placement, especially when using Wandin frames to ensure uniform batten spacing.

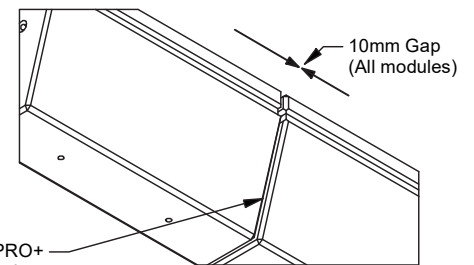
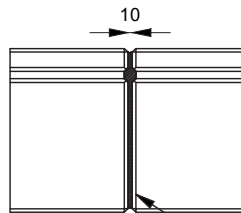

Surface Mounting Concrete Modules

Concrete modules can be placed on compacted crushed rock or concrete slab.
(Site engineer to specify sub surface construction)

All concrete modules have ferules provided for mounting to concrete surfaces.

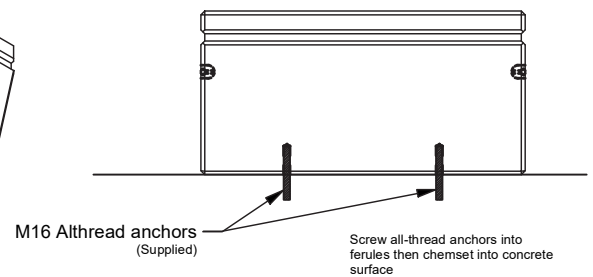
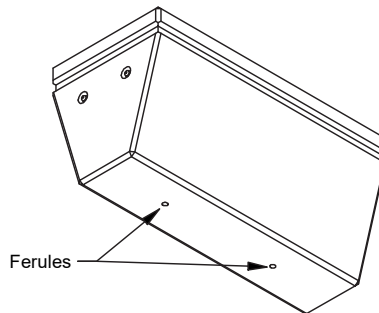

Typical Steel Leg Surface Mount

Surface mounted steel legs typically require a M12 ground anchor.
(Anchor length recommended by a site engineer)

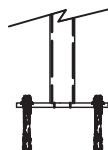

Typical Inground Steel Leg Mount

Mount inground frames at the recommended seat height of 430mm from surface.
(Foundation to be determined by the site engineer.)

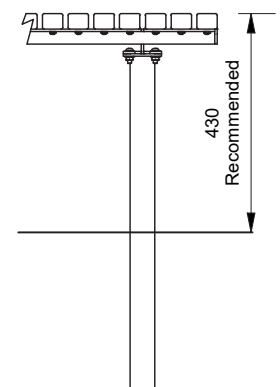

Wandin Mounting Options

Spacers & Frame Joining Accessories



Spacers

Spacers are used to correctly space Wandin seats and benches from each other. Wandin furniture is designed to bolt end to end using these spacers, ensuring uniform batten spacing. Spacers are included automatically when two or more Wandin seats or benches are to be bolted together. For flexibility, two spacer variants are available. One for simple joining, and one that includes a leg mount that provides an alternate position for leg placement.

31847
Standard Spacer

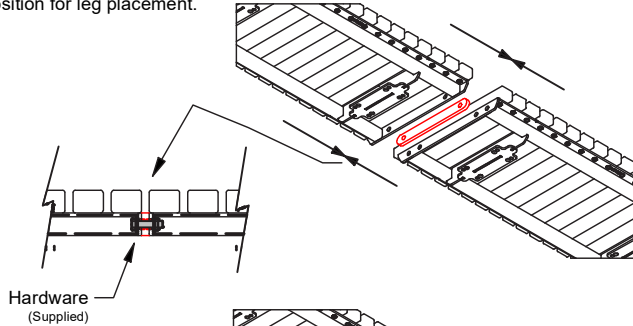

Hardware
(Supplied)

32071
Spacer with Mount

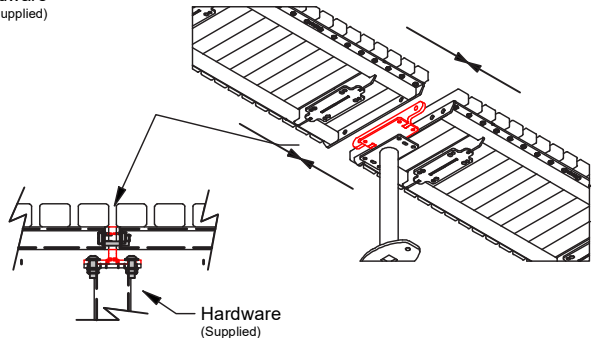
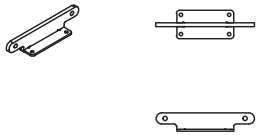

Hardware
(Supplied)

Mounting Wandin Frames to Concrete Plinths

Wandin frames can be mounted to concrete plinths. There is a concrete plinth available for most Wandin module profiles.

1. Remove the two battens above mounting plates to access mounting holes
2. Once frame is in position, drill holes through mounting plate to anchor depth

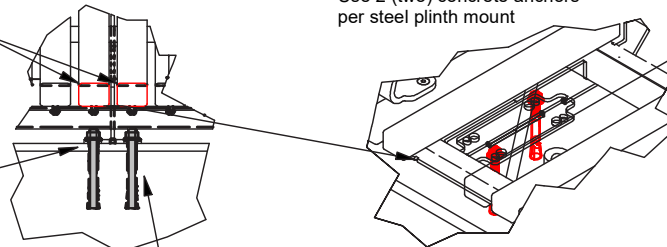

Use 2 (two) concrete anchors per steel plinth mount

3. Fit and fix concrete anchors
2 per steel mount (Supplied)

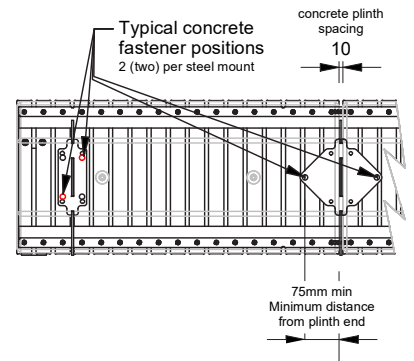

Concrete Module End Mounts

Wandin frames can also be mounted to the ends of the concrete modules to create a flush frame to concrete mount without the need for a steel leg below the frame.

32509
Concrete End Mount Plate

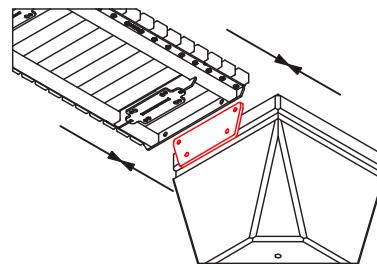
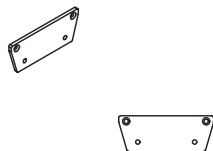

1. Fit End Mount Plate to Wandin frame using countersunk bolts.
2. Bring frame to the concrete bench. Align centrally and top of seat level with top of concrete bench.
3. Once frame is in position, drill holes through mounting plate to anchor depth.
4. Fit and fix concrete anchors. (Supplied)



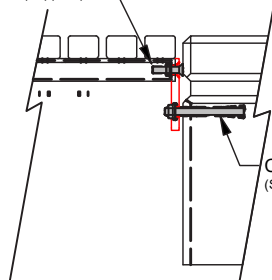



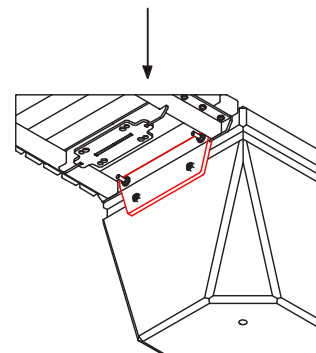

Countersunk Screw Fixing
(Supplied)

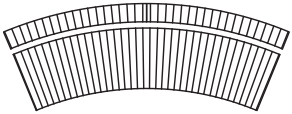
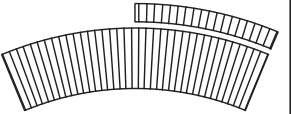

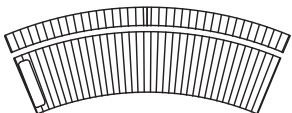
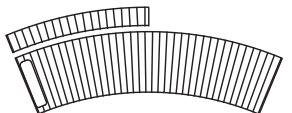
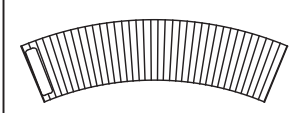
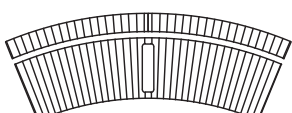
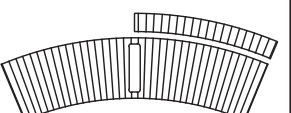
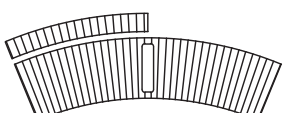
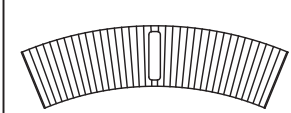

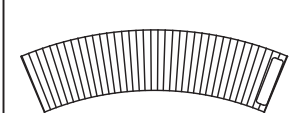



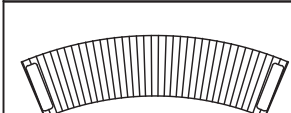



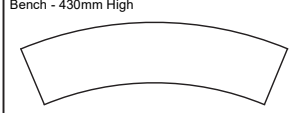

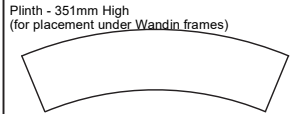
Concrete Anchors
(Supplied)

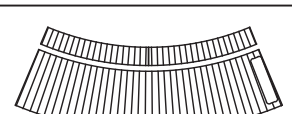
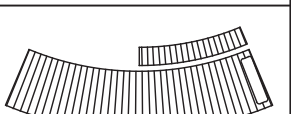

Wandin Large Curved Modules











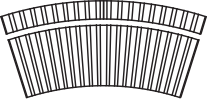

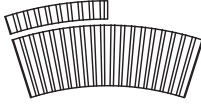

Concave Modules	Concave Seat W1X/LGE/CC	Concave Half-Back Right W1X/LGE/CCR	Concave Half-Back Left W1X/LGE/CCL	Bench W1X/LGE/BN
No Armrests	 P/N: 10CC/R19	 P/N: 1CCR/R19	 P/N: 10CCL/R19	 P/N: 11/R19
Left Armrest	 P/N: 10CC/LA/R19		 P/N: 10CCL/LA/R19	 P/N: 11/LA/R19
Middle Armrest	 P/N: 10CC/MA/R19	 P/N: 10CCR/MA/R19	 P/N: 10CCL/MA/R19	 P/N: 11/MA/R19
Right Armrest	 P/N: 10CC/RA/R19	 P/N: 10CCR/RA/R19		 P/N: 11/RA/R19
Two Armrests	 P/N: 10CC/2A/R19	 P/N: 10CCR/2A/R19	 P/N: 10CCL/2A/R19	 P/N: 11/2A/R19

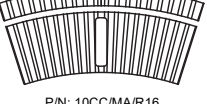



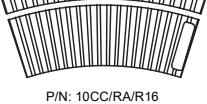
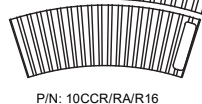

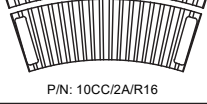
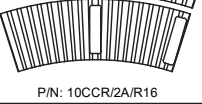
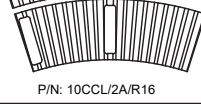

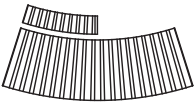

Convex Modules	Convex Seat W1X/LGE/CV	Convex Half-Back Right W1X/LGE/CVR	Convex Half-Back Left W1X/LGE/CVL	Concrete Modules
No Armrests	 P/N: 10CV/R19	 P/N: 10CVR/R19	 P/N: 10CVL/R19	Bench - 430mm High  538kg P/N: 31538
Left Armrest	 P/N: 10CV/LA/R19		 P/N: 10CVL/LA/R19	Plinth - 351mm High (for placement under Wandin frames)  419kg P/N: 31537
Middle Armrest	 P/N: 10CV/MA/R19	 P/N: 10CVR/MA/R19	 P/N: 10CVL/MA/R19	
Right Armrest	 P/N: 10CV/RA/R19	 P/N: 10CVR/RA/R19		
Two Armrests	 P/N: 10CV/2A/R19	 P/N: 10CVR/2A/R19	 P/N: 10CVL/2A/R19	

DRAFFIN
Street Furniture

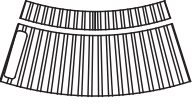
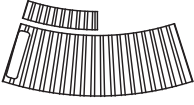

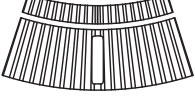
Wandin Medium Curved Modules



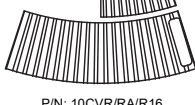
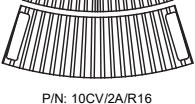
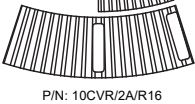
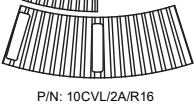







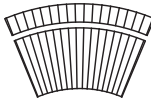



Concave Modules	Concave Seat W1X/MED/CC	Concave Half-Back Right W1X/MED/CCR	Concave Half-Back Left W1X/MED/CCL	Bench W1X/MED/BN
No Armrests	 P/N: 10CC/R16	 P/N: 10CCR/R16	 P/N: 10CCL/R16	 P/N: 11/R16
Left Armrest	 P/N: 10CC/LA/R16		 P/N: 10CCL/LA/R16	 P/N: 11/LA/R16
Middle Armrest	 P/N: 10CC/MA/R16	 P/N: 10CCR/MA/R16	 P/N: 10CCL/MA/R16	 P/N: 11/MA/R16
Right Armrest	 P/N: 10CC/RA/R16	 P/N: 10CCR/RA/R16		 P/N: 11/RA/R16
Two Armrests	 P/N: 10CC/2A/R16	 P/N: 10CCR/2A/R16	 P/N: 10CCL/2A/R16	 P/N: 11/2A/R16



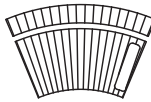



Convex Modules	Convex Seat W1X/MED/CV	Convex Half-Back Right W1X/MED/CVR	Convex Half-Back Left W1X/MED/CVL	Concrete Modules
No Armrests	 P/N: 10CV/R16	 P/N: 10CVR/R16	 P/N: 10CVL/R16	Bench - 430mm High  375kg P/N: 32489
Left Armrest	 P/N: 10CV/LA/R16		 P/N: 10CVL/LA/R16	Plinth - 351mm High (for placement under Wandin frames)  293kg P/N: 31070
Middle Armrest	 P/N: 10CV/MA/R16	 P/N: 10CVR/MA/R16	 P/N: 10CVL/MA/R16	
Right Armrest	 P/N: 10CV/RA/R16	 P/N: 10CVR/RA/R16		
Two Armrests	 P/N: 10CV/2A/R16	 P/N: 10CVR/2A/R16	 P/N: 10CVL/2A/R16	

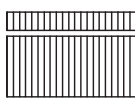
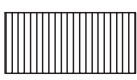
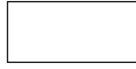
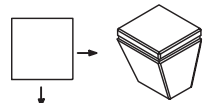
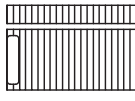
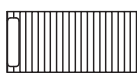

DRAFFIN
Street Furniture

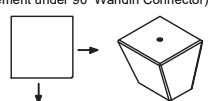
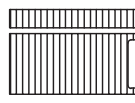

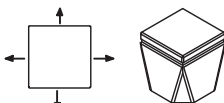
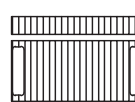
Wandin Small Modules and Minor Modules

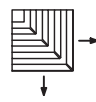
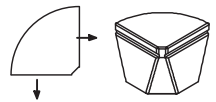
Concave Modules	Concave Seat W1X/SML/CC	Convex Seat W1X/SML/CV	Bench W1X/SML/BN	Concrete Modules
No Armrests	 P/N: 10CC/R25	 P/N: 10CV/R25	 P/N: 11/R25	Bench - 430mm High  234kg P/N: 32488
Left Armrest	 P/N: 10CC/LA/R25	 P/N: 10CV/LA/R25	 P/N: 11/LA/R25	Plinth - 351mm High (for placement under Wandin frames)  183kg P/N: 27368
Right Armrest	 P/N: 10CC/RA/R25	 P/N: 10CV/RA/R25	 P/N: 11/RA/R25	
Two Armrests	 P/N: 10CC/2A/R25	 P/N: 10CV/2A/R25	 P/N: 11/2A/R25	

Straight Modules	Straight Seat W1X/STR/ST	Straight Bench W1X/STR/BN	Straight Concrete Modules	Minor Concrete Modules
No Armrests	 P/N: 10S/85	 P/N: 11S/85	Bench - 430mm High  279kg P/N: 31355	90° Concrete Bench - 430mm High  132kg P/N: 32401
Left Armrest	 P/N: 10S/LA/85	 P/N: 11S/LA/85	Plinth - 351mm High (for placement under Wandin frames)  216kg P/N: 27369	90° Concrete Plinth (for placement under 90° Wandin Connector)  103kg P/N: 32400
Right Armrest	 P/N: 10S/RA/85	 P/N: 11S/RA/85		Concrete Junction Bench  158kg P/N: 32415
Two Armrests	 P/N: 10S/2A/85	 P/N: 11S/2A/85	Minor Bench 90° Corner Bench "Connector" W1X/CNR  P/N: 11S/CNR	Curved Concrete Corner Bench  126kg P/N: 32402

Angled Steel Corners	45° Steel Angle Corner Joiner W1X/SC45  P/N: 30329	90° Steel Angle Corner Joiner W1X/SC90  P/N: 30328
----------------------	--	--

DRAFFIN
Street Furniture

